

**nobilis**<sup>®</sup>

Wohnwelten Living environments

20



Lebensräume  
gestalten

Designing  
living spaces



# Wohnkonzepte

## Living concepts

**Was macht aus Räumen ein Zuhause? Natürlich die Menschen, die dort leben. Hinzu kommt die Art, wie sie sich einrichten. Vom kleinsten Detail bis zur durchgängigen Gestaltung der einzelnen Räume – als Marktführer im Bereich Einbauküchen entwickeln wir seit Jahrzehnten hochwertige Systemmöbel mit hohem individuellen Planungsanspruch. Für uns die ideale Voraussetzung, um unsere Planungsexpertise und unseren hohen Anspruch an Qualität und Gebrauchsfähigkeit auch in den Bereichen Bad und Wohnen unter Beweis zu stellen. Und zwar ausgesprochen erfolgreich! Das Ergebnis: Wir führen Küche, Wohnen und Essen ganzheitlich zu einem Lebensraum zusammen. Für Ihr individuelles Zuhause!**

—

What turns rooms into a home? The people who live there, of course. Plus the way they furnish them. From the smallest detail to the consistent design of the individual rooms – as a market leader in the fitted kitchen sector, we have been developing high-quality system furniture that meets high individual planning standards for decades. For us, this is the ideal prerequisite for demonstrating our planning expertise and our high standards of quality and usability, including in bathroom and living areas. And we do it with great success! The result: we combine kitchen, living and dining into one living space in a holistic way. For your individual home!

**4** **Zuhause erleben** Experience your home

**12** **Wohnwelten** Living environments

**78** **Planungsvorschläge** Planning suggestions

**95** **Dekore und Griffe** Décors and handles





# Zuhause erleben

## Experience your home

**Für Familien ist der Tag immer in Bewegung, auch zuhause.  
Hier spielen nicht nur die Kinder, hier spielt das Leben.  
Schön, wenn die Einrichtung genau hierfür gemacht ist  
und von morgens bis abends alles mitmacht.  
Willkommen zuhause!**

---

For families, the day is always full of movement, even at home.  
Not only do children play here, but this is where life plays out.  
So it can only be a good thing if the furniture is made for exactly  
this and can cope with everything that's thrown at it day and night.  
Welcome home!







Zuhause erleben Experience your home

6-7











**DIE ANKLEIDE WIRD  
ZUM KLEIDERTRAUM.**  
TURN YOUR DRESSING ROOM  
INTO A CLOTHING DREAM.





## **GUTEN TAG! HELLO!**

**Fertig machen für die Arbeit, der Schulranzen ist gepackt, rein in die Jacken und los geht's. Nach Hause kommen, Gäste empfangen. Hier ist immer was los.**

—  
Get ready for work, pack the school satchel, pull your jackets on and off you go. Come home and welcome guests. There's always something going on here.



**WAHRE ORDNUNGLIEBE –  
MIT DER PASSENDEN GARDEROBE.**  
A TRUE LOVE OF ORDER –  
WITH THE RIGHT WARDROBE.



10-11

**WENN DAS FAMILIENFRÜHSTÜCK  
ZUM GENUSSMOMENT WIRD.**  
WHEN THE FAMILY BREAKFAST  
BECOMES A MOMENT TO ENJOY.



**Zuhause erleben** Experience your home



**WENN WOHNEN ZUM WOHNGEFÜHL WIRD.**  
WHEN LIVING BECOMES A FEELING OF WELL-BEING.



## **ZUSAMMENKOMMEN** GET TOGETHER

**Das Frühstück mit der Familie, ein gemeinsamer Spieleabend,  
mit Freunden kochen oder einfach auf dem Sofa entspannen:  
Hier ist Raum für alles.**

---

Breakfast with the family, an evening playing games together,  
cooking with friends or simply relaxing on the sofa: there's space  
for everything here.

12-13



54  
Genussmoment  
Moments of  
enjoyment



64  
Ordnungs-  
liebe  
A love  
of order



# 14 Wohngefühl Living atmosphere



# Wohnwelten Living environments

**Individualität hat viele Gesichter. Daher bieten unsere Einrichtungselemente auch unendliche Möglichkeiten, einzelne Räume oder komplette Wohnwelten zu gestalten und zu verändern. Lassen Sie sich inspirieren!**

—  
Individuality has many faces. This is why our furnishing elements also offer unlimited possibilities for designing individual rooms or complete living environments as well as modifying them. Get some inspiration!

# 72 Kleider- traum Clothing dreams







# Wohngefühl Living atmosphere

**Das Leben einfach nach den eigenen Vorstellungen gestalten. Unsere intelligenten und hochwertigen Systemmöbel bieten jede Menge Freiheit im Hinblick auf Materialien, Farben und Maße.**

—  
Design your life according to your own ideas. Our intelligent and high-quality system furniture offers lots of freedom when it comes to materials, colours and dimensions.



TOUCH

**332 Lacklaminat, Alpinweiß supermatt**

332 Lacquered laminate, alpine white supermatt







## LEICHT GEMACHT MADE EASY

**Helle Eiche Sierra plus mattweiße Fronten kreieren auf dezente Art eine besondere Leichtigkeit. Die Regale bieten die ideale Bühne für individuelle Dekorationen.**

Light oak Sierra plus matt white fronts subtly create a special feeling of lightness. The shelves offer the ideal platform for individual decorative items.



TOUCH

**341 Lacklaminat, Steingrau supermatt**  
341 Lacquered laminate, stone grey supermatt

TOUCH

**334 Lacklaminat, Schiefergrau supermatt**  
334 Lacquered laminate, slate grey supermatt





## KLARES DESIGN CLEAR DESIGN

**Das Zusammenspiel von klaren Linien und supermatten Oberflächen in abgestimmten Graunuancen wirkt elegant und sehr zeitgemäß.**

---

The interplay of clear lines and super matt surfaces in coordinated grey shades creates an elegant and very contemporary impression.





## NATÜRLICH KOMBINIERT NATURALLY COMBINED

**Die Materialkombination aus der warmen Eiche Havanna und alpinweißer Oberfläche schafft eine spannende und dennoch wohnliche Atmosphäre. Schöner Blickfang: eine lockere Planung, die durch beleuchtete Wandborde betont wird.**

—  
The combination of materials in the form of warm Havana oak and alpine white surfaces creates an exciting but homely atmosphere. Lovely eye-catcher: a casual design that is emphasised by illuminated wall-mounted shelves.





**FASHION**

**168 Lack, Alpinweiß matt**

168 Lacquer, honed alpine white

**STRUCTURA**

**402 Eiche Havanna Nachbildung**

402 Havana oak reproduction





## STATEMENT STATEMENT

**Ein starker Auftritt für ein sehr aktuelles Ambiente. Die Kunst des Wohnens präsentiert sich in schwarzer Eiche Nero kombiniert mit Auszügen in ultramattem Rostrot. Schön praktisch: die Anti-Fingerprint Beschichtung.**

A strong appearance for a very contemporary ambience. The art of living is presented in black Nero oak with pull-outs in ultra-matt rust red. Amazingly practical: anti-fingerprint coating.





## STRUCTURA

### 403 Eiche Nero Nachbildung

403 Nero oak reproduction

## EASYTOUCH

### 963 Lacklaminat, Rostrot ultramatt

963 Lacquered laminate, rust red ultra matt





24-25

Wohngefühl | Living atmosphere





## ENTSPANNTE NATÜRLICHKEIT RELAXED NATURALNESS

Zur Ruhe kommen, entspannen und Kraft tanken. Wo geht das besser als in einem gemütlichen Zuhause, das mit schlichten Einrichtungselementen, warmen Lichtquellen, viel Holz und einer gedeckten Farbgebung punktet? Besonders zeitgemäß wirken die Möbel aus hellen Hölzern übrigens in Kombination mit Betonwänden oder Steinböden.

Rest, relax and recharge your batteries. What better place to do this than in a cosy home with simple furnishing elements, warm sources of light, lots of wood and a muted colour scheme? The furniture made from light wood looks especially contemporary in combination with concrete walls or stone floors.





**TOUCH**

—  
**341 Lacklaminat, Steingrau supermatt**  
341 Lacquered laminate, stone grey supermatt





## ENTSPANNT RELAXED

**Das luftige Regal- und Ablageelement in heller Eiche San Remo kreiert ein modernes und offenes Wohlfühlambiente und bietet Raum für die Inszenierung der Lieblings-Accessoires.**

The airy shelving element in light oak Sanremo creates a modern and open feel-good ambience and offers space for showcasing your favourite accessories.





## ZEITLOS MODERN TIMELESSLY MODERN

**Das grifflose Design der Wandelemente zeigt sich ausgesprochen modern und elegant. In der Kombination mit edlen Hölzern entsteht so ein zeitloser Look, der jeden Raum bereichert.**

—  
The handleless design of the wall elements looks exceptionally modern and elegant. Combined with fine woods, this creates a timeless look that enriches any room.





**TOUCH**

**334 Lacklaminat, Schiefergrau supermatt**

334 Lacquered laminate, slate grey supermatt



30-31



Wohngefühl | Living atmosphere







#### TOUCH

---

**340 Lacklaminat, Schwarz supermatt**

340 Lacquered laminate, black supermatt



#### STRUCTURA

---

**402 Eiche Havanna Nachbildung**

402 Havana oak reproduction

## AUFGESCHOBEN MOVED

**Schiebetüren als Gestaltungselement schaffen Stauraum und geben den Möbeln im naturbelassenen Eiche Havanna Look einen coolen Touch.**

---

Sliding doors as a design element create storage space and give the furniture in natural Havana look oak a cool touch.



**EASYTOUCH**

**963 Lacklaminat, Rostrot ultramatt**

963 Lacquered laminate, rust red ultra matt



**RIVA**

**889 Beton schiefergrau Nachbildung**

889 Concrete Slate Grey reproduction





## STARKE OPTIK STRONG LOOKS

**Ein individuelles Ensemble mit Wow-Effekt. Die Rückwand im Beton-Look schafft den perfekten Rahmen für kontrastierende Schränke in Rostrot mit ultramatten Anti-Fingerprint Oberflächen.**

An individual ensemble with the wow factor. The rear wall in a concrete look creates the perfect backdrop for contrasting cupboards in rust red with ultra matt anti-fingerprint surfaces.

34-35



—  
**INLINE**

**551 Lack, Alpinweiß matt**

551 Lacquer, honed alpine white

—  
**KANSAS**

**597 Eiche Sierra Nachbildung**

597 Sierra oak reproduction

Wohngefühl | Living atmosphere





# BLICKFANG

## EYE-CATCHER

**Zwei exklusive Programme ergeben zusammen ein absolutes Highlight. Die quadratischen Schränke im modernen Landhaus-Look überzeugen mit individuell gearbeiteten Rahmentüren. Das Auszugelement in elegantem Mattlack wirkt durch die integrierte Griffmulde besonders clean.**

Two exclusive ranges give rise to an absolute highlight. The square cupboard boards in modern country house look impress with their individually crafted framed doors. The pull-out element in elegant matt lacquer looks particularly smart thanks to the integrated recessed handles.



36-37

Wohngefühl | Living atmosphere





# URBANE GEMÜTLICHKEIT

## URBAN COSINESS

**Ein Stil, der auf entspannte Art urban und wohnlich zugleich wirkt. Natürliche Materialien und Graunuancen sowie dekorative Grünpflanzen schaffen das ideale Umfeld für sehr zeitgemäße Systemmöbel in hochwertigen Holzoptiken und Oberflächen, die an den Landhausstil erinnern.**

A style that looks both urban and homely at the same time, and in a relaxed way. Natural materials and grey nuances as well as decorative green plants create the ideal environment for a very contemporary furniture system in a high quality wood finish with surfaces that are reminiscent of the country house style.



**GENT****741 Lacklaminat, Steingrau**

741 Lacquered laminate, stone grey

**STRUCTURA****402 Eiche Havanna Nachbildung**

402 Havana oak reproduction



## ÜBERRASCHENDE DETAILS

### SURPRISING DETAILS

**Doppelt schön – und praktisch. Die variablen Smartcube Regale inszenieren individuelle Deko-Ideen und die puristischen Schrankelemente bieten nicht nur Stauraum, sondern überzeugen mit praktischen Barklappen. Zusätzlicher Hingucker: das dezente Dekor der Gent-Fronten mit feiner Rillenstruktur.**

Doubly beautiful – and practical. The variable Smartcube shelves showcase individual decorative ideas and the puristic cupboard elements not only offer storage space, but also impress with practical bar flaps. An additional eye-catcher is the subtle décor of the Gent fronts with fine groove structure.







## MARMOR STYLE MARBLE STYLE

**Cool kombiniert! Die Marmor Teramo Nachbildung gibt den Hängemodulen mit Barklappen ihren puren und individuellen Touch und passt sich unterschiedlichen Wohnstilen gekonnt an.**

Cool combination! The Teramo marble reproduction gives the suspended units with fold down fronts their pure and individual touch. This fits with different living styles.





## COLOR CONCEPT

---

### **274 Marmor Teramo Nachbildung**

274 Teramo marble reproduction

## TOUCH

---

### **338 Lacklaminat, Seidengrau supermatt**

338 Lacquered laminate, satin grey supermatt





## SCHÖN KOMPAKT WONDERFULLY COMPACT

**Ein spannender Tiefen-Mix wird zum echten Hingucker und erweist sich als besonders praktisch: denn die ausladenden Auszüge sorgen für eine großzügige Ablagefläche und mehr Stauraum.**

—  
An exciting mix of depths becomes a real eye-catcher and proves to be particularly practical: the protruding pull-outs provide a generous storage area and more storage space.





**STRUCTURA**

**405 Eiche Sierra Nachbildung**

405 Sierra oak reproduction

**LUX**

**819 Lack, Seidengrau Hochglanz**

819 Lacquer, satin grey high gloss





## KONTRASTVOLLE SCHÖNHEIT CONTRASTING BEAUTY

Starke Kontraste in Schwarz und Weiß wirken klassisch, hochwertig und zeitlos. Dazu eine grafische Formsprache sowie individuelle Accessoires. Für ein Zuhause, das mit Persönlichkeit überzeugt und in dem die Einrichtung effektiv in Szene gesetzt wird. Passend zum hochwertigen Look: Elemente in Schiefergrau.

Strong contrasts in black and white look classic, high quality and timeless. Coupled with a graphical design language and individual accessories for a home that impresses with its personality and that effectively showcases the furnishings which match the elements in slate grey.







## GLASKLAR CRYSTAL CLEAR

**Hell trifft dunkel und schafft so eine klare, urbane Ästhetik. Glas als Designelement bringt eine zusätzliche Leichtigkeit ins Spiel.**

—  
Light meets dark, creating a clear, urban aesthetic. Glass as a design element brings additional light into play.







TOUCH

---

**334 Lacklaminat, Schiefergrau supermatt**

334 Lacquered laminate, slate grey supermatt

TOUCH

---

**332 Lacklaminat, Alpinweiß supermatt**

332 Lacquered laminate, alpine white supermatt



**RIVA**

**892 Beton grau Nachbildung**  
892 Concrete grey reproduction

**EASYTOUCH**

**961 Lacklaminat, Grafit schwarz ultramatt**  
961 Lacquered laminate, graphite black ultra matt







## GRAUSTUFEN GREYSSCALE

**Puristische Auszüge in Beton-Optik und grafit-schwarze Elemente mit praktischer Antifinger-Print Beschichtung werden von der Rückwand zu einem harmonischen Gesamtbild zusammengeführt. Eine starke Kombination, die cool und elegant zugleich wirkt.**

---

Puristic pull-outs in a concrete look and graphite black elements with a practical anti-fingerprint coating are brought together by the rear wall, forming a harmonious feature. A strong combination that looks both cool and elegant.

50-51

**LUX**

**823 Lack, Schiefergrau Hochglanz**  
823 Lacquer, slate grey high gloss

**STRUCTURA**

**402 Eiche Havanna Nachbildung**  
402 Havana oak reproduction



Wohngefühl | Living atmosphere





## AKZENTE SETZEN SETTING ACCENTS

**Das Wandsystem in schiefergrauem Hochglanz überzeugt durch sein Design und die praktischen Auszüge. Schöner Kontrast: Elemente aus Eiche Havanna.**

---

The wall system in slate-grey high gloss inspires with its design and practical pull-outs. Beautiful contrasting elements made from Havanna oak.

## SPIELRAUM FREEDOM TO PLAY

**So vielseitig kann eine moderne Stauraumgestaltung aussehen. Hingucker: die integrierte Pultplatte in strukturierter Eiche Sierra Optik setzt als Designelement ein starkes Zeichen.**

—  
Modern storage design can look this versatile. Eye-catcher: the integrated console panel in a structured Sierra oak look makes a strong statement as a design element.







**FASHION**

**173 Lack, Weiß matt**

173 Lacquer, honed white



# Genuss- moment

## Moments of enjoyment

**Essen genießen, wie und wo man es mag.  
Wenn Kochen, Essen und Wohnen fließend  
ineinanderübergehen, sorgen unsere Möbel  
für die passende Verbindung.**

—  
Enjoy your food how and wherever you want.  
When cooking, eating and living merge seam-  
lessly into one another, our furniture provides  
the ideal links between them.







**STRUCTURA**

**405 Eiche Sierra Nachbildung**  
405 Sierra oak reproduction

**LEICHTIGKEIT**  
LIGHTNESS

**Genuss gut geplant! Ein Essbereich, in dem dank einer klaren Formsprache und exklusiven Oberflächengestaltung alles perfekt zusammen passt.**

Well-planned enjoyment! A dining area in which everything fits together perfectly thanks to a clear design language and exclusive surface design.

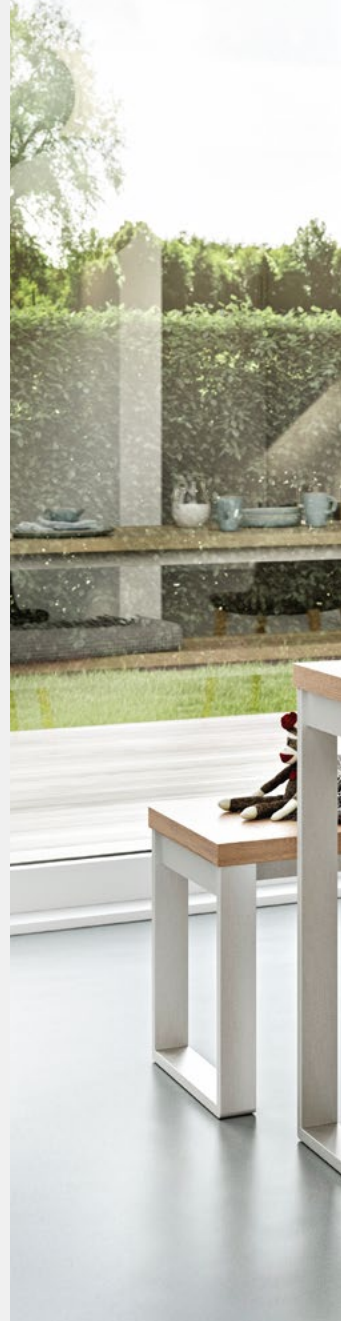





58-59

Genusmoment Moments of enjoyment



TOUCH

**341 Lacklaminat, Steingrau supermatt**

341 Lacquered laminate, stone grey supermatt

TOUCH

**340 Lacklaminat, Schwarz supermatt**

340 Lacquered laminate, black supermatt





# EINLADEND

## INVITING

**Kreativ geplant! Frische Kräuter sind jetzt jederzeit griffbereit am Tisch. Auszüge bieten jede Menge Stauraum für Gläser und Geschirr. Und das Design des Tisches rundet das Gesamtbild ästhetisch ab.**

—  
Creatively planned! Fresh herbs are now always within reach at the table. Pull-outs offer lots of storage space for glasses and crockery. And the design of the table completes the overall aesthetic.



60-61



## HARMONIE HARMONY

**Der klassische Wandschrank überzeugt mit äußeren und inneren Werten und ist dank praktischer Auszüge, Schubladen und Regal-Flächen ein wahres Stauraumwunder. Kombiniert mit dem passenden Tisch entsteht eine ruhige und wohnliche Atmosphäre.**

—  
The classic wall cupboard looks superb with its external and internal features and is a space miracle thanks to practical pull-outs, drawers and shelf space. Combined with the matching table, it makes for a calm and homely atmosphere.





## TOUCH

**334 Lacklaminat, Schiefergrau supermatt**  
334 Lacquered laminate, slate grey supermatt



## KOMPLETTPROGRAMM COMPLETE RANGE

**Die warmen Eiche Sierra Oberflächen verbinden Wohnen und Essen auf sehr moderne Art und gestalten den Raum ganzheitlich. Seidengraue Elemente unterstreichen diesen entspannten Stil perfekt.**

The warm Sierra oak surfaces combine living and eating in a very modern way and ensures a holistic design for the room. Silk grey elements perfectly underpin this relaxed style.







## TOUCH

---

**338 Lacklaminat, Seidengrau supermatt**

338 Lacquered laminate, satin grey supermatt

## STRUCTURA

---

**405 Eiche Sierra Nachbildung**

405 Sierra oak reproduction



# Ordnungs- liebe

## A love of order

**Am Flur führt in der Regel kein Weg vorbei. Schön, wenn sich dieser Bereich für Gäste repräsentativ und gut organisiert gestaltet.**

---

There is no way around the hall to get to the rest of the house. Even better if you can make this area a showcase for guests and get it well organised.





## PLATZ GENUG ENOUGH SPACE

**Variabilität in bester Form. Das Stollen-Regalsystem ist beliebig erweiterbar und wird durch Schränke, Auszüge, Ablagen und Kleiderstangen zu einem wahren Raumwunder. Highlight: die Stollen können optional mit integrierter Beleuchtung ausgestattet werden.**

Variability at its best. The pole-mounted shelving system can be extended at will and becomes a true space miracle with cupboards, pull-outs, shelves and clothes rails. Highlight: the pole-mounted shelving can be optionally equipped with integrated lighting.







**TOUCH**

**334 Lacklaminat, Schiefergrau supermatt**

334 Lacquered laminate, slate grey supermatt



68-69



Ordnungsliebe A love of order



#### STRUCTURA

**405 Eiche Sierra Nachbildung**  
405 Sierra oak reproduction

#### EASYTOUCH

**961 Lacklaminat, Grafit schwarz ultramatt**  
961 Lacquered laminate, graphite black ultra matt







## ORGANISATIONSTALENT ORGANISATIONAL TALENT

**Diese Garderobe beweist ihr Organisationstalent täglich auf's Neue. Durch Ablageflächen, Auszüge und Kleiderstange hilft sie den Alltag zu organisieren. Praktisch, wenn Schlüssel und Handy griffbereit abgelegt werden können und Schal und Schirm ihren Platz finden. Und dann noch der rasche Blick in den beleuchteten Spiegel.**

—  
This hanging and drawer system is a useful addition to any household every day. With shelves, pull-outs and clothes rails, it helps to organise everyday life. Practical: keys and mobile phones can be stored within easy reach and your scarf and umbrella have a designated place. And then a quick glance in the illuminated mirror.





## KONTRASTPROGRAMM CONTRASTING PROGRAMME

**Bruchstein-Optik trifft hier auf ein optional indirekt beleuchtetes Stollen-Regalsystem, das bei der ganzen Familie mit Schubladen, hohen Auszügen und einem Spiegel punktet. Eine spannende Kombination, die den Alltag bereichert.**

A quarry stone look meets an optional indirectly illuminated pole-mounted shelving system that looks stunning with its co-ordinated drawers, high pull-outs and a mirror. An exciting combination that enriches everyday life.





LUX

819 Lack, Seidengrau Hochglanz

819 Lacquer, satin grey high gloss





# Kleidertraum

## Clothing dreams

**Die eigene Ankleide muss kein Traum bleiben. Intelligente Module und praktische Detaillösungen passen sich jeder Raumgröße an und bringen auf stilvolle Art Ordnung ins Leben.**

—  
Having your own dressing room need not remain a dream. Intelligent modules and practical detail solutions can adapt to all sizes of room and bring order to life in a stylish way.





74-75

Kleidertraum Clothing dreams



TOUCH

334 Lacklaminat, Schiefergrau supermatt

334 Lacquered laminate, slate grey supermatt





# MEHR FLEXIBILITÄT GREATER FLEXIBILITY

**Stilvoll und flexibel zugleich. Das variable Stollen-Regalsystem bietet mit seinen Ablageböden, Schubladen, Auszügen und Kleiderstangen viel Platz für Kleidung und Accessoires und ist zudem beliebig erweiterbar.**

Stylish and flexible at the same time. With its shelves, drawers, pull-out drawers and clothes rails, the variable pole-mounted shelving system offers lots of space for clothing and accessories and can also be extended as required.



76-77

Kleidertraum Clothing dreams



**TOUCH**

**341 Lacklaminat, Steingrau supermatt**

341 Lacquered laminate, stone grey supermatt





## RAUMWUNDER A SPACE MIRACLE

**Der wohnliche Ankleidebereich mit viel Raum für Kleidung und andere Lieblingsstücke bietet ideale Voraussetzungen für individuelle Planungen. Die perfekte Synthese aus dem klassischen Systemmöbel und dem Stollen-Regalsystem erfüllt so unterschiedlichste Ansprüche.**

The cosy dressing area with lots of space for clothing and other favourite pieces offers the ideal prerequisites for individual plans. The perfect synthesis of classic system furniture and the pole-mounted shelving system meets the most varied of demands.



## PLANUNGSVORSCHLÄGE

Unsere Wohnmöbel können Sie immer individuell und passend für Ihre Bedürfnisse kombinieren. Ihr Fachhändler vor Ort unterstützt Sie gerne bei der Planung.

### WSET02

Seite 14-17  
page 14-17

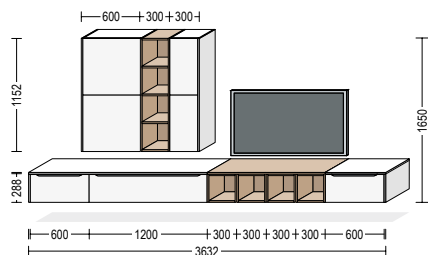

## PLANNING SUGGESTIONS

You can always combine our furniture individually to suit your needs. Your local dealer will be happy to help you with your plans.

### WSET01

Seite 18-19  
page 18-19

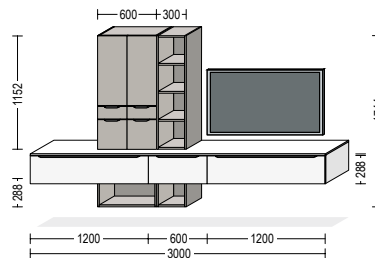

### WSET06

Seite 24-27  
page 24-27

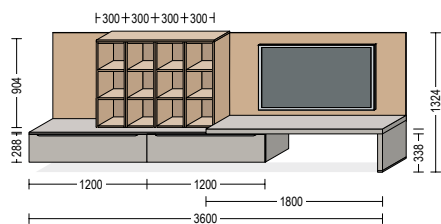

### WSET09

Seite 28-29  
page 28-29

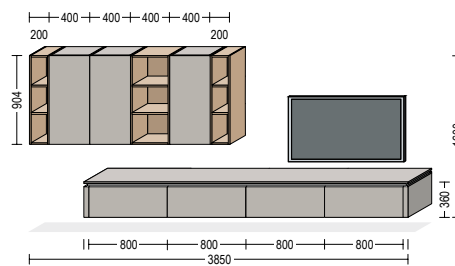

### WSET16

Seite 34-35  
page 34-35

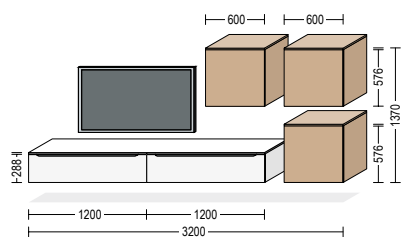

### WSET08

Seite 36-39  
page 36-39

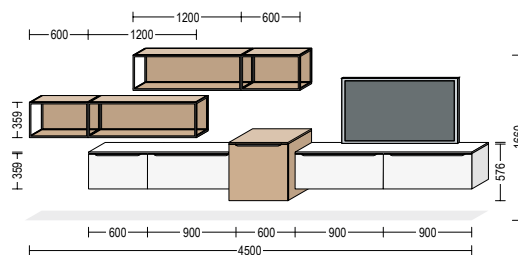

### WSET12

Seite 44-47  
page 44-47

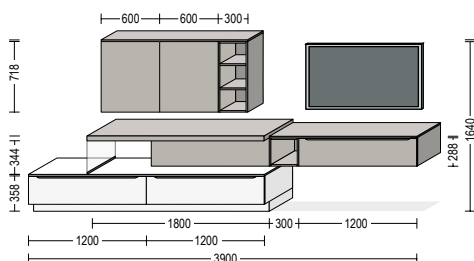

### WSET07

Seite 48-49  
page 48-49

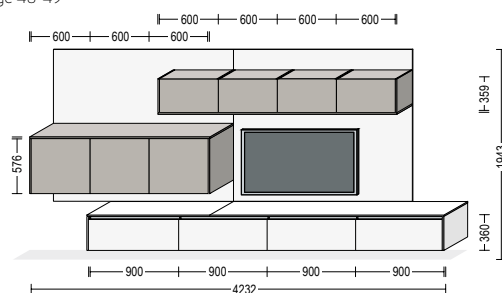



### WSET05

Seite 20-21  
page 20-21

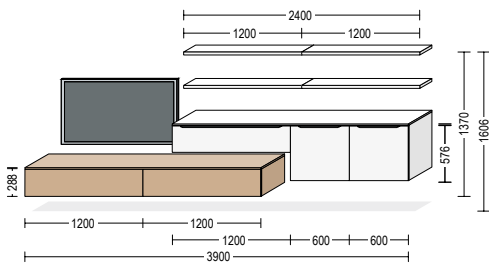

### WSET04

Seite 22-23  
page 22-23

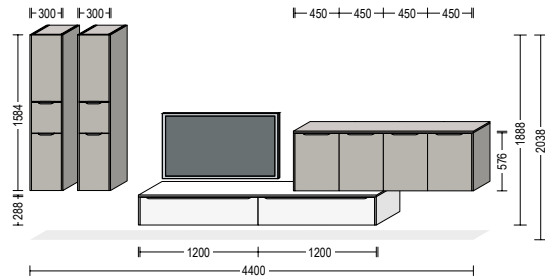

### WSET11

Seite 30-31  
page 30-31

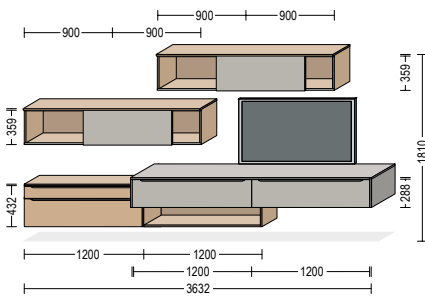

### WSET15

Seite 32-33  
page 32-33

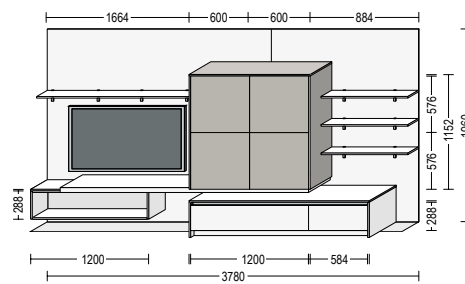

### WSET13

Seite 40-41  
page 40-41

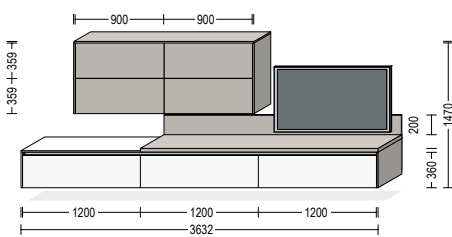

### WSET14

Seite 42-43  
page 42-43

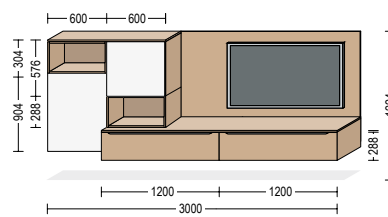

### WSET03

Seite 50-51  
page 50-51

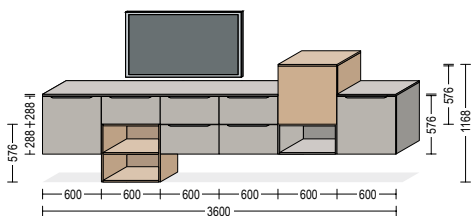

### WSET10

Seite 52-53  
page 52-53

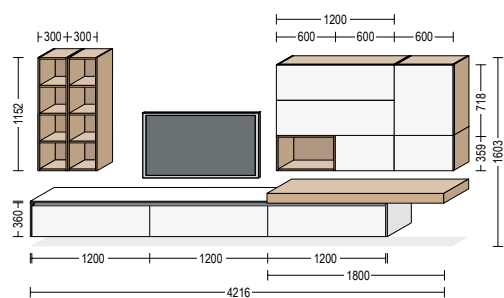

# SPEZIFIKATIONEN SPECIFICATIONS

Die Planungsvorschläge enthalten keine Leuchten oder Griffleisten-Mehrpriese. Diese müssen zusätzlich zur Set-Artikelnummer bestellt werden.

Sondermaße gegen Mehrpreis. TV-Geräte und Dekorationsartikel sind nicht enthalten.

The planning suggestions do not include lights or surcharges for handles. These must be ordered in addition to the set item number.

Special dimensions for a surcharge. TVs and decorative items are not included.

## Wohngefühl Living atmosphere

### WSET01

Seite 18-19  
page 18-19

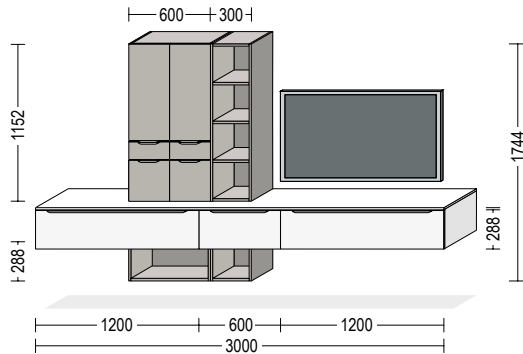

- |                |   |                 |  |
|----------------|---|-----------------|--|
| 2 × BUA 120-29 | <b>Badezimmer-Auszugschrank, 1 Auszug, B × H × T: 1200 × 288 × 461 mm</b><br>Bathroom pull-out unit, 1 pull-out, w × h × d: 1200 × 288 × 461 mm | 1 × APSLN60     | <b>Arbeitsplatte APSLN Slim Line, 16 mm stark, B × T: 3004 × 487 mm</b><br>Worktop APSLN Slim Line, 16 mm thick, w × d: 3004 × 487 mm  |
| 1 × WR 60-36   | <b>Wandregal, B × H × T: 600 × Sondermaß 288 × 335 mm</b><br>Open shelf wall unit, w × h × d: 600 × special size 288 × 335 mm                   | 2 × BMSA 30-115 | <b>Badezimmer-Midischrank, 1 Tür, 1 Schubkasten, 1 Auszug, 2 Einlegeböden, B × H × T: 300 × 1152 × 320 mm</b><br>Bathroom Midi unit, 1 door, 1 drawer, 1 pull-out, 2 shelves, w × h × d: 300 × 1152 × 320 mm |
| 1 × WR 30-36   | <b>Wandregal, B × H × T: 300 × Sondermaß 288 × 335 mm</b><br>Open shelf wall unit, w × h × d: 300 × special size 288 × 335 mm                   | 1 × BR 30-115   | <b>Badezimmer-Midiregal, 3 feste Böden, B × H × T: 300 × 1152 × 335 mm</b><br>Bathroom Midi shelf, 3 fixed shelves, w × h × d: 300 × 1152 × 335 mm   |
| 1 × BUA 60-29  | <b>Badezimmer-Auszugschrank, 1 Auszug, B × H × T: 600 × 288 × 461 mm</b><br>Bathroom pull-out unit, 1 pull-out, w × h × d: 600 × 288 × 461 mm   |                 |  |

### WSET02

Seite 14-17  
page 14-17

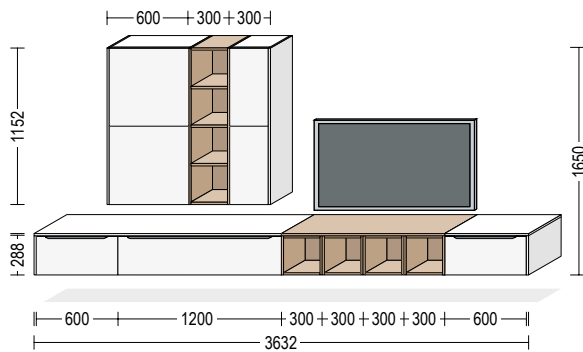

- |                |   |                |  |
|----------------|---|----------------|--|
| 2 × BUA 60-29  | <b>Badezimmer-Auszugschrank, 1 Auszug, B × H × T: 600 × 288 × 461 mm</b><br>Bathroom pull-out unit, 1 pull-out, w × h × d: 600 × 288 × 461 mm   | 2 × W 60-01    | <b>Wandschrank, 1 Tür, 1 Einlegeboden, B × H × T: 600 × Sondermaß 576 × 320 mm</b><br>Wall unit, 1 door, 1 shelf, w × h × d: 600 × special size 576 × 320 mm |
| 1 × BUA 120-29 | <b>Badezimmer-Auszugschrank, 1 Auszug, B × H × T: 1200 × 288 × 461 mm</b><br>Bathroom pull-out unit, 1 pull-out, w × h × d: 1200 × 288 × 461 mm | 1 × BR 30-115  | <b>Badezimmer-Midiregal, 3 feste Böden, B × H × T: 300 × 1152 × 335 mm</b><br>Bathroom Midi shelf, 3 fixed shelves, w × h × d: 300 × 1152 × 335 mm           |
| 4 × BUR 30-29  | <b>Badezimmer-Unterschrankregal, B × H × T: 300 × 288 × 482 mm</b><br>Bathroom open shelf base unit, w × h × d: 300 × 288 × 482 mm              | 2 × W 30-01    | <b>Wandschrank, 1 Tür, 1 Einlegeboden, B × H × T: 300 × Sondermaß 576 × 320 mm</b><br>Wall unit, 1 door, 1 shelf, w × h × d: 300 × special size 576 × 320 mm |
| 1 × ADB16 59   | <b>Abdeckboden, 16 mm stark, B × T: 1818 × 487 mm</b><br>Top shelf, 16 mm thick, w × d: 1818 × 487 mm   | 2 × BMW 16-115 | <b>Abschlusswange, 16 mm stark, H × T: 1152 × 344 mm</b><br>Upright at end of run, 16 mm thick, h × d: 1152 × 344 mm   |
| 1 × ADB16 59   | <b>Abdeckboden, 16 mm stark, B × T: 1200 × 487 mm</b><br>Top shelf, 16 mm thick, w × d: 1200 × 487 mm   | 1 × PTOS       | <b>Mechanische Öffnungsunterstützung</b><br>Opening support mechanism  |
| 1 × ADB16 59   | <b>Abdeckboden, 16 mm stark, B × T: 618 × 487 mm</b><br>Top shelf, 16 mm thick, w × d: 618 × 487 mm   |                |  |
| 2 × BUW 16-29  | <b>Abschlusswange, 16 mm stark, H × T: 288 × 485 mm</b><br>Upright at end of run, 16 mm thick, h × d: 288 × 485 mm                              |                |  |



\*Bitte beachten Sie, dass ein Distanzband für die Montage erforderlich ist, um Kollisionen zwischen der Front und den horizontal angebrachten Teilen zu vermeiden.  
Please note that a spacer tape is required when planning top shelves and folding/lifting door and swivel flap units, to prevent the front contacting the top shelf.

## Wohngefühl Living atmosphere

### WSET03

Seite 50-51  
page 50-51

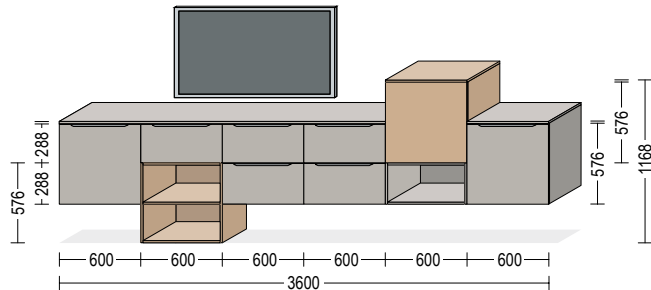

- |                |  |               |  |
|----------------|--|---------------|--|
| 3 × BU 60-58   | <b>Badezimmer-Unterschrank, 1 Tür, 1 Einlegeboden,</b><br><b>B × H × T: 600 × 576 × 461 mm</b><br>Bathroom base unit, 1 door, 1 shelf, w × h × d: 600 × 576 × 461 mm           | 1 × BUR 60-29 | <b>Badezimmer-Unterschrankregal, B × H × T: 600 × 288 × 482 mm</b><br>Bathroom open shelf base unit, w × h × d: 600 × 288 × 482 mm |
| 1 × BUR 60-58  | <b>Badezimmer-Unterschrankregal, 1 fester Boden,</b><br><b>B × H × T: 600 × 576 × 482 mm</b><br>Bathroom open shelf base unit, 1 fixed shelf,<br>w × h × d: 600 × 576 × 482 mm | 1 × ADB16 59  | <b>Abdeckboden, 16 mm stark, B × T: 2402 × 487 mm</b><br>Top shelf, 16 mm thick, w × d: 2402 × 487 mm                              |
| 1 × BUA 60-29  | <b>Badezimmer-Auszugschrank, 1 Auszug, B × H × T: 600 × 288 × 461 mm</b><br>Bathroom pull-out unit, 1 pull-out, w × h × d: 600 × 288 × 461 mm                                  | 1 × ADB16 59  | <b>Abdeckboden, 16 mm stark, B × T: 604 × 487 mm</b><br>Top shelf, 16 mm thick, w × d: 604 × 487 mm                                |
| 2 × BU2A 60-58 | <b>Badezimmer-Auszugschrank, 2 Auszüge, B × H × T: 600 × 576 × 461 mm</b><br>Bathroom pull-out unit, 2 pull-outs, w × h × d: 600 × 576 × 461 mm                                | 1 × ADB16 59  | <b>Abdeckboden, 16 mm stark, B × T: 602 × 487 mm</b><br>Top shelf, 16 mm thick, w × d: 602 × 487 mm                                |
|                |  | 1 × PTO5      | <b>Mechanische Öffnungsunterstützung</b><br>Opening support mechanism  |

### WSET04\*

Seite 22-23  
page 22-23

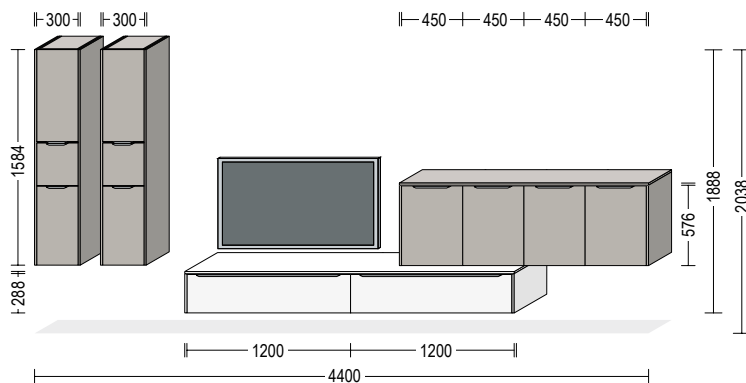

- |                |   |               |  |
|----------------|---|---------------|--|
| 2 × BMA 30-158 | <b>Badezimmer-Midischrank, 1 Tür, 1 Auszug, 1 Tür, 3 Einlegeböden,</b><br><b>B × H × T: 300 × 1584 × 320 mm</b><br>Bathroom Midi unit, 1 door, 1 pull-out, 1 door, 3 shelves,<br>w × h × d: 300 × 1584 × 320 mm | 4 × BU 45-58  | <b>Badezimmer-Unterschrank, 1 Tür, 1 Einlegeboden,</b><br><b>B × H × T: 450 × 576 × Sondermaß 320 mm</b><br>Bathroom base unit, 1 door, 1 shelf,<br>w × h × d: 450 × 576 × special size 320 mm |
| 4 × BMW 16-158 | <b>Abschlusswange, 16 mm stark, H × T: 1584 × 344 mm</b><br>Upright at end of run, 16 mm thick, h × d: 1584 × 344 mm  | 1 × ADB16 35  | <b>Abdeckboden, 16 mm stark, B × T: 1836 × 346 mm</b><br>Top shelf, 16 mm thick, w × d: 1836 × 346 mm  |
| 2 × BUA 120-29 | <b>Badezimmer-Auszugschrank, 1 Auszug, B × H × T: 1200 × 288 × 461 mm</b><br>Bathroom pull-out unit, 1 pull-out, w × h × d: 1200 × 288 × 461 mm   | 1 × BUW 16-58 | <b>Abschlusswange, 16 mm stark, H × T: 576 × Sondermaß 344 mm</b><br>Upright at end of run, 16 mm thick, w × d: 576 × special size 344 mm  |
| 1 × ADB16 59   | <b>Abdeckboden, 16 mm stark, B × T: 2436 × 487 mm</b><br>Top shelf, 16 mm thick, w × d: 2436 × 487 mm   | 1 × BUW 16-58 | <b>Abschlusswange, 16 mm stark, H × T: 579 × Sondermaß 344 mm</b><br>Upright at end of run, 16 mm thick, w × d: 579 × special size 344 mm  |
| 2 × BUW 16-29  | <b>Abschlusswange, 16 mm stark, H × T: 288 × 485 mm</b><br>Upright at end of run, 16 mm thick, h × d: 288 × 485 mm  |               |  |

# SPEZIFIKATIONEN SPECIFICATIONS

Die Planungsvorschläge enthalten keine Leuchten oder Griffleisten-Mehrpriese. Diese müssen zusätzlich zur Set-Artikelnummer bestellt werden. Sondermaße gegen Mehrpreis. TV-Geräte und Dekorationsartikel sind nicht enthalten.

The planning suggestions do not include lights or surcharges for handles. These must be ordered in addition to the set item number. Special dimensions for a surcharge. TVs and decorative items are not included.

## Wohngefühl Living atmosphere

### WSET05

Seite 20-21  
page 20-21

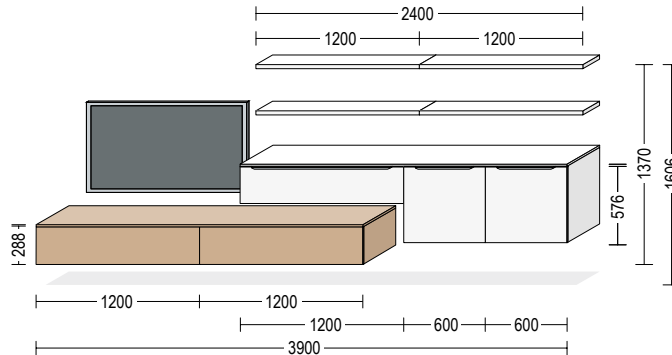

- |                       |  |                     |   |
|-----------------------|--|---------------------|---|
| <b>3 × BUA 120-29</b> | <b>Badezimmer-Auszugschrank, 1 Auszug, B × H × T: 1200 × 288 × 461 mm</b><br>Bathroom pull-out unit, 1 pull-out, w × h × d: 1200 × 288 × 461 mm            | <b>4 × WBLG 120</b> | <b>LED Glas-Lichtbord, 30 mm stark, B × T: 1200 × 200 mm</b><br>LED glass lighted wall shelf, 30 mm thick, w × d: 1200 × 200 mm |
| <b>2 × SOS-SET</b>    | <b>Sensomatic Öffnungssystem</b><br>Sensomatic opening system  | <b>1 × LSET60</b>   | <b>LED-Startset</b><br>LED starter set  |
| <b>2 × ADB16 59</b>   | <b>Abdeckboden, 16 mm stark, B × T: 2404 × 487 mm</b><br>Top shelf, 16 mm thick, w × d: 2404 × 487 mm  | <b>1 × LFSSET30</b> | <b>LED-Folgeset</b><br>LED follow-up set  |
| <b>2 × BU 60-58</b>   | <b>Badezimmer-Unterschrank, 1 Tür, 1 Einlegeboden, B × H × T: 600 × 576 × 461 mm</b><br>Bathroom base unit, 1 door, 1 shelf, w × h × d: 600 × 576 × 461 mm |                     |   |

### WSET06

Seite 24-27  
page 24-27

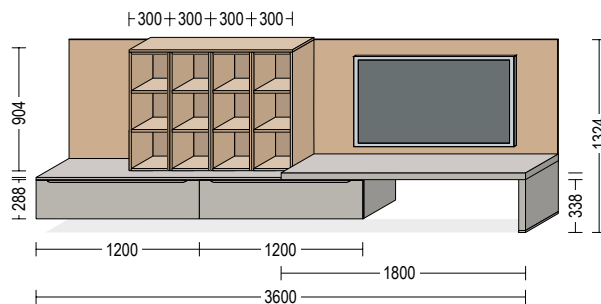

- |                       |   |                     |   |
|-----------------------|---|---------------------|---|
| <b>2 × BUA 120-29</b> | <b>Badezimmer-Auszugschrank, 1 Auszug, B × H × T: 1200 × 288 × 461 mm</b><br>Bathroom pull-out unit, 1 pull-out, w × h × d: 1200 × 288 × 461 mm | <b>1 × ADB16 35</b> | <b>Abdeckboden, 16 mm stark, B × T: 1204 × 337 mm</b><br>Top shelf, 16 mm thick, w × d: 1204 × 337 mm   |
| <b>1 × ADB16 59</b>   | <b>Abdeckboden, 16 mm stark, B × T: 1802 × 487 mm</b><br>Top shelf, 16 mm thick, w × d: 1802 × 487 mm   | <b>1 × ADB50 59</b> | <b>Abdeckboden, 50 mm stark, B × T: 1800 × 487 mm</b><br>Top shelf, 50 mm thick, w × d: 1800 × 487 mm   |
| <b>1 × NV203</b>      | <b>Nischenwandverkleidung, 16 mm stark, B × H: 602 × 904 mm</b><br>Niche cladding, 16 mm thick, w × h: 602 × 904 mm                             | <b>1 × UWA 50</b>   | <b>Abschlusswange inkl. Bodenprofil, 50 mm stark, H × T: 388 × 485 mm</b><br>Upright at end of run incl. floor seal, 50 mm thick, h × d: 388 × 485 mm |
| <b>4 × WR 30-03</b>   | <b>Wandregal, 2 feste Böden, B × H × T: 300 × 904 × 335 mm</b><br>Open shelf wall unit, 2 fixed shelves, w × h × d: 300 × 904 × 335 mm          | <b>1 × NV203</b>    | <b>Nischenwandverkleidung, 16 mm stark, B × H: 1800 × 870 mm</b><br>Niche cladding, 16 mm thick, w × h: 1800 × 870 mm                                 |



## Wohngefühl Living atmosphere

### WSET07

Seite 48-49  
page 48-49

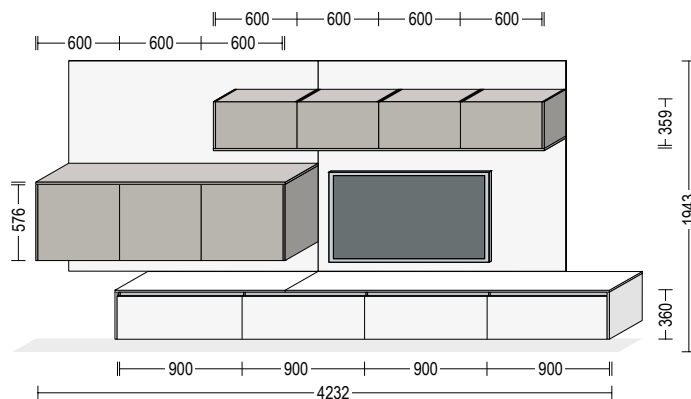

- |                |  |              |  |
|----------------|--|--------------|--|
| 4 × NBUA 90-36 | <b>Badezimmer-Auszugschrank, 1 Auszug, B × H × T: 900 × 360 × 461 mm</b><br>Bathroom pull-out unit, 1 pull-out, w × h × d: 900 × 360 × 461 mm              | 2 × NV203    | <b>Nischenwandverkleidung, 16 mm stark, B × H: 1816 × 1567 mm</b><br>Niche cladding, 16 mm thick, w × h: 1816 × 1567 mm  |
| 1 × APSLN60    | <b>Arbeitsplatte APSLN Slim Line, 16 mm stark, B × T: 1218 × 487 mm</b><br>Worktop APSLN Slim Line, 16 mm thick, w × d: 1218 × 487 mm                      | 4 × W 60-36  | <b>Wandschrank, 1 Tür, B × H × T: 600 × 359 × 320 mm</b><br>Wall unit, 1 door, w × h × d: 600 × 359 × 320 mm   |
| 1 × APSLN60    | <b>Arbeitsplatte APSLN Slim Line, 16 mm stark, B × T: 2418 × 487 mm</b><br>Worktop APSLN Slim Line, 16 mm thick, w × d: 2418 × 487 mm                      | 1 × ADB16 35 | <b>Abdeckboden, 16 mm stark, B × T: 2434 × 346 mm</b><br>Top shelf, 16 mm thick, w × d: 2434 × 346 mm  |
| 2 × BUW 16-36  | <b>Abschlusswange, 16 mm stark, H × T: 360 × 485 mm</b><br>Upright at end of run, 16 mm thick, h × d: 360 × 485 mm   | 2 × WW 16-01 | <b>Abschluss-/Zwischenwange, 16 mm stark, H × T: Sondermaß 359 × 344 mm</b><br>Upright at end of run/intermediate upright, 16 mm thick, h × d: special size 359 × 344 mm |
| 3 × BU 60-58   | <b>Badezimmer-Unterschrank, 1 Tür, 1 Einlegeboden, B × H × T: 600 × 576 × 461 mm</b><br>Bathroom base unit, 1 door, 1 shelf, w × h × d: 600 × 576 × 461 mm | 2 × PTO5     | <b>Mechanische Öffnungsunterstützung</b><br>Opening support mechanism  |
| 1 × ADB16 59   | <b>Abdeckboden, 16 mm stark, B × T: 1834 × 487 mm</b><br>Top shelf, 16 mm thick, w × d: 1834 × 487 mm  |              |  |
| 2 × BUW 16-58  | <b>Abschlusswange, 16 mm stark, H × T: 576 × 485 mm</b><br>Upright at end of run, 16 mm thick, h × d: 576 × 485 mm   |              |  |

### WSET08

Seite 36-39  
page 36-39

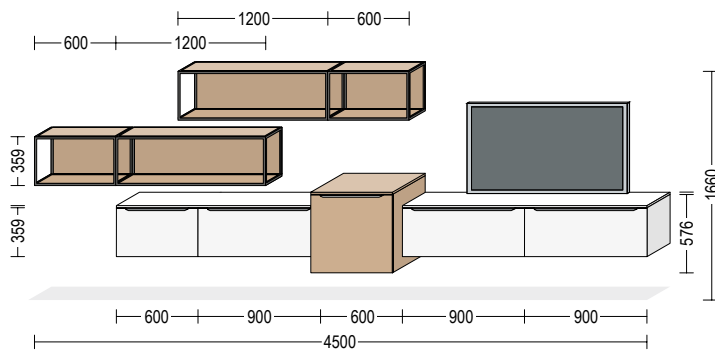

- |               |  |                 |   |
|---------------|--|-----------------|---|
| 1 × WKB 60-36 | <b>Wandschrank mit Barklappe, 1 Klappe, B × H × T: 600 × 359 × 320 mm</b><br>Wall unit with bar flap, 1 flap, w × h × d: 600 × 359 × 320 mm                | 2 × WRSC 60-36  | <b>Wandregal Smartcube, B × H × T: 600 × 359 × 250 mm</b><br>Open shelf wall unit Smartcube, w × h × d: 600 × 359 × 250 mm                      |
| 3 × WKB 90-36 | <b>Wandschrank mit Barklappe, 1 Klappe, B × H × T: 900 × 359 × 320 mm</b><br>Wall unit with bar flap, 1 flap, w × h × d: 900 × 359 × 320 mm                | 2 × RKSC 60-36  | <b>Rückwandverkleidung Smartcube, 16 mm stark, B × H: 600 × 321,5 mm</b><br>Back panel cladding Smartcube, 16 mm thick, w × h: 600 × 321.5 mm   |
| 1 × ADB16 35  | <b>Abdeckboden, 16 mm stark, B × T: 1502 × 346 mm</b><br>Top shelf, 16 mm thick, w × d: 1502 × 346 mm  | 2 × WRSC 120-36 | <b>Wandregal Smartcube, B × H × T: 1200 × 359 × 250 mm</b><br>Open shelf wall unit Smartcube, w × h × d: 1200 × 359 × 250 mm                    |
| 1 × BU 60-58  | <b>Badezimmer-Unterschrank, 1 Tür, 1 Einlegeboden, B × H × T: 600 × 576 × 461 mm</b><br>Bathroom base unit, 1 door, 1 shelf, w × h × d: 600 × 576 × 461 mm | 2 × RKSC 120-36 | <b>Rückwandverkleidung Smartcube, 16 mm stark, B × H: 1200 × 321,5 mm</b><br>Back panel cladding Smartcube, 16 mm thick, w × h: 1200 × 321.5 mm |
| 1 × ADB16 59  | <b>Abdeckboden, 16 mm stark, B × T: 604 × 487 mm</b><br>Top shelf, 16 mm thick, w × d: 604 × 487 mm  | 1 × PTO5        | <b>Mechanische Öffnungsunterstützung</b><br>Opening support mechanism   |
| 1 × ADB16 35  | <b>Abdeckboden, 16 mm stark, B × T: 1802 × 346 mm</b><br>Top shelf, 16 mm thick, w × d: 1802 × 346 mm  |                 |   |

# SPEZIFIKATIONEN SPECIFICATIONS

Die Planungsvorschläge enthalten keine Leuchten oder Griffleisten-Mehrpriese. Diese müssen zusätzlich zur Set-Artikelnummer bestellt werden.

Sondermaße gegen Mehrpreis. TV-Geräte und Dekorationsartikel sind nicht enthalten.

The planning suggestions do not include lights or surcharges for handles. These must be ordered in addition to the set item number.

Special dimensions for a surcharge. TVs and decorative items are not included.

## Wohngefühl Living atmosphere

### WSET09

Seite 28-29  
page 28-29

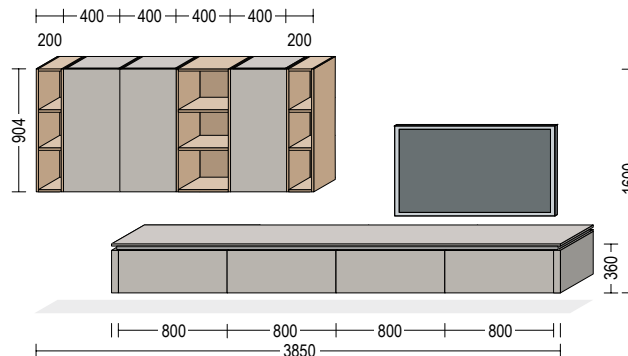

- |                       |   |                     |   |
|-----------------------|---|---------------------|---|
| <b>4 × NBUA 80-36</b> | <b>Badezimmer-Auszugschrank, 1 Auszug, B × H × T: 800 × 360 × 461 mm</b><br>Bathroom pull-out unit, 1 pull-out, w × h × d: 800 × 360 × 461 mm | <b>2 × WR 20-03</b> | <b>Wandregal, 2 feste Böden, B × H × T: 200 × 904 × 335 mm</b><br>Open shelf wall unit, 2 fixed shelves, w × h × d: 200 × 904 × 335 mm  |
| <b>1 × APSLN60</b>    | <b>Arbeitsplatte APSLN Slim Line, 16 mm stark, B × T: 3304 × 487 mm</b><br>Worktop APSLN Slim Line, 16 mm thick, w × d: 3304 × 487 mm         | <b>3 × NW 40-03</b> | <b>Wandschrank, 1 Tür, 2 Einlegeböden, B × H × T: 400 × 904 × 320 mm</b><br>Wall unit, 1 door, 2 shelves, w × h × d: 400 × 904 × 320 mm |
| <b>2 × NUWF36 50</b>  | <b>Abschluss-Frontwange, B × H × T: 50 × 360 × Sondermaß 482 mm</b><br>Front at end of run upright, w × h × d: 50 × 360 × special size 482 mm | <b>1 × WR 40-03</b> | <b>Wandregal, 2 feste Böden, B × H × T: 400 × 904 × 335 mm</b><br>Open shelf wall unit, 2 fixed shelves, w × h × d: 400 × 904 × 335 mm  |

### WSET10

Seite 52-53  
page 52-53

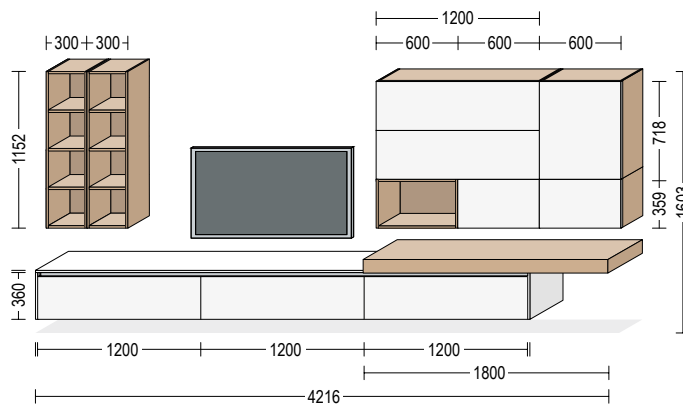

- |                        |  |                       |   |
|------------------------|--|-----------------------|---|
| <b>3 × NBUA 120-36</b> | <b>Badezimmer-Auszugschrank, 1 Auszug, B × H × T: 1200 × 360 × 461 mm</b><br>Bathroom pull-out unit, 1 pull-out, w × h × d: 1200 × 360 × 461 mm    | <b>2 × WKB 60-36</b>  | <b>Wandschrank mit Barklappe, 1 Klappe, B × H × T: 600 × 359 × 320 mm</b><br>Wall unit with bar flap, 1 flap, w × h × d: 600 × 359 × 320 mm   |
| <b>1 × ADB16 59</b>    | <b>Abdeckboden, 16 mm stark, B × T: 2418 × 487 mm</b><br>Top shelf, 16 mm thick, w × d: 2418 × 487 mm  | <b>1 × WFL 120-02</b> | <b>Wandschrank falt-Lifttür, 1 falt-Lifttür, 2 Originalfronten, 2 Einlegeböden, B × H × T: 1200 × 718 × 320 mm</b><br>Wall unit with folding/lifting door, 1 folding/lifting door, 2 original fronts, 2 shelves, w × h × d: 1200 × 718 × 320 mm |
| <b>2 × BUW 16-36</b>   | <b>Abschlusswange, 16 mm stark, H × T: 360 × 485 mm</b><br>Upright at end of run, 16 mm thick, h × d: 360 × 485 mm                                 | <b>1 × MP-SD</b>      | <b>Mehrpriese Servo-Drive</b><br>Surcharge for servo motor  |
| <b>1 × APP</b>         | <b>Pultplatte, 100 mm stark, B × T: 1800 × 500 mm</b><br>Console panel, 100 mm thick, w × d: 1800 × 500 mm   | <b>1 × W 60-02</b>    | <b>Wandschrank, 1 Tür, 2 Einlegeböden, B × H × T: 600 × 718 × 320 mm</b><br>Wall unit, 1 door, 2 shelves, w × h × d: 600 × 718 × 320 mm   |
| <b>2 × BR 30-115</b>   | <b>Badezimmer-Midiregal, 3 feste Böden, B × H × T: 300 × 1152 × 335 mm</b><br>Bathroom Midi shelf, 3 fixed shelves, w × h × d: 300 × 1152 × 335 mm | <b>1 × PTOS</b>       | <b>Mechanische Öffnungsunterstützung</b><br>Opening support mechanism   |
| <b>1 × WR 60-36</b>    | <b>Wandregal, B × H × T: 600 × 359 × 335 mm</b><br>Open shelf wall unit, w × h × d: 600 × 359 × 335 mm   |                       |   |



WSET11

Seite 30-31  
page 30-31

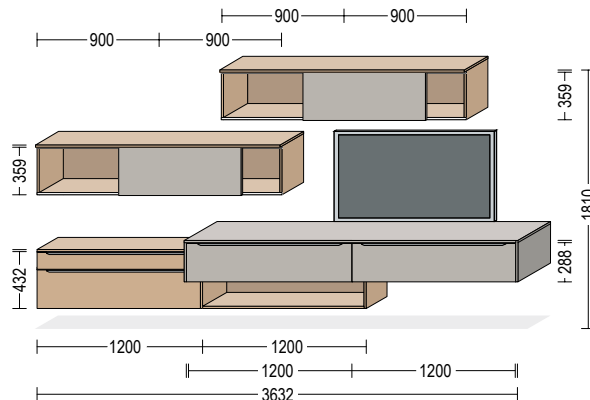

- 1 × BUSA 120-43 **Badezimmer-Auszugschrank, 1 Schubkasten, 1 Auszug, B × H × T: 1200 × 432 × Sondermaß 320 mm**  
Bathroom pull-out unit, 1 drawer, 1 pull-out, w × h × d: 1200 × 432 × special size 320 mm
- 1 × ADB16 35 **Abdeckboden, 16 mm stark, B × T: 1202 × 346 mm**  
Top shelf, 16 mm thick, w × d: 1202 × 346 mm
- 1 × WR 120-36 **Wandregal, B × H × T: 1200 × Sondermaß 288 × 335 mm**  
Open shelf wall unit, w × h × d: 1200 × special size 288 × 335 mm
- 2 × BUA 120-29 **Badezimmer-Auszugschrank, 1 Auszug, B × H × T: 1200 × 288 × 461 mm**  
Bathroom pull-out unit, 1 pull-out, w × h × d: 1200 × 288 × 461 mm
- 1 × ADB16 59 **Abdeckboden, 16 mm stark, B × T: 2436 × 487 mm**  
Top shelf, 16 mm thick, w × d: 2436 × 487 mm

- 2 × BUW 16-29 **Abschlusswange, 16 mm stark, H × T: 288 × 485 mm**  
Upright at end of run, 16 mm thick, h × d: 288 × 485 mm
- 4 × WSTK 90-36 **Wandschrank für Schiebetüren, B × H × T: 900 × 359 × 320 mm**  
Wall unit for sliding doors, w × h × d: 900 × 359 × 320 mm
- 2 × WSTP 90-36 **Schiebetür, B × H: 900 × 359 mm**  
Sliding door, w × h: 900 × 359 mm
- 2 × WSTP 250 **Laufprofil-Set für Schiebetüren, B × H × T: 1800 × 16 × 8 mm**  
Runner profile set for sliding doors, w × h × d: 1800 × 16 × 8 mm
- 2 × ADB16 36 **Abdeckboden, 16 mm stark, B × T: 1804 × 353,5 mm**  
Top shelf, 16 mm thick, w × d: 1804 × 353.5 mm

WSET12

Seite 44-47  
page 44-47

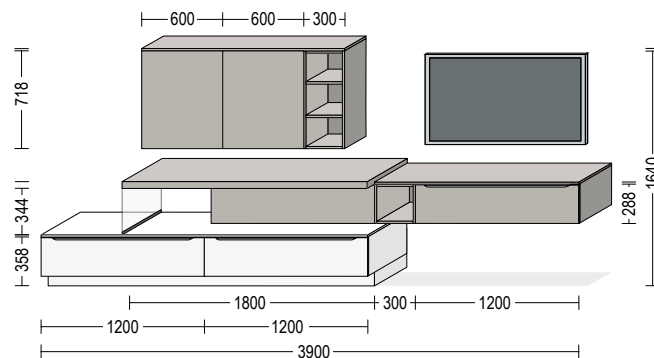

- 2 × UA 120-29 **Auszugschrank/Kochstellenschrank, 1 Auszug, B × H × T: 1200 × 288 × 561 mm**  
Pull-out unit/hot plate unit, 1 pull-out, w × h × d: 1200 × 288 × 561 mm
- 2 × MP-PSO **Mehrp reis-Sockel**  
Surcharge for plinth
- 1 × ADB16 59 **Abdeckboden, 16 mm stark, B × T: 2404 × 587 mm**  
Top shelf, 16 mm thick, w × d: 2404 × 587 mm
- 1 × UWG 34 **Glaswange, 8 mm stark, H × T: 360 × 585 mm**  
Glass upright, 8 mm thick, h × d: 360 × 585 mm
- 1 × ADB50 59 **Abdeckboden, 50 mm stark, B × T: 1800 × 587 mm**  
Top shelf, 50 mm thick, w × d: 1800 × 587 mm
- 2 × BUA 120-29 **Badezimmer-Auszugschrank, 1 Auszug, B × H × T: 1200 × 288 × 461 mm**  
Bathroom pull-out unit, 1 pull-out, w × h × d: 1200 × 288 × 461 mm

- 1 × BUR 30-29 **Badezimmer-Unterschrankregal, B × H × T: 300 × 288 × 482 mm**  
Bathroom open shelf base unit, w × h × d: 300 × 288 × 482 mm
- 1 × ADB16 59 **Abdeckboden, 16 mm stark, B × T: 1502 × 487 mm**  
Top shelf, 16 mm thick, w × d: 1502 × 487 mm
- 2 × W 60-02 **Wandschrank, 1 Tür, 2 Einlegeböden, B × H × T: 600 × 718 × 320 mm**  
Wall unit, 1 door, 2 shelves, w × h × d: 600 × 718 × 320 mm
- 1 × WR 30-02 **Wandregal, 2 feste Böden, B × H × T: 300 × 718 × 335 mm**  
Open shelf wall unit, 2 fixed shelves, w × h × d: 300 × 718 × 335 mm
- 1 × ADB16 36 **Abdeckboden, 16 mm stark, B × T: 1504 × 346 mm**  
Top shelf, 16 mm thick, w × d: 1504 × 346 mm
- 1 × PTO5 **Mechanische Öffnungsunterstützung**  
Opening support mechanism

# SPEZIFIKATIONEN SPECIFICATIONS

Die Planungsvorschläge enthalten keine Leuchten oder Griffleisten-Mehrpriese. Diese müssen zusätzlich zur Set-Artikelnummer bestellt werden. Sondermaße gegen Mehrpreis. TV-Geräte und Dekorationsartikel sind nicht enthalten.

The planning suggestions do not include lights or surcharges for handles. These must be ordered in addition to the set item number. Special dimensions for a surcharge. TVs and decorative items are not included.

## Wohngefühl Living atmosphere

### WSET13

Seite 40-41  
page 40-41

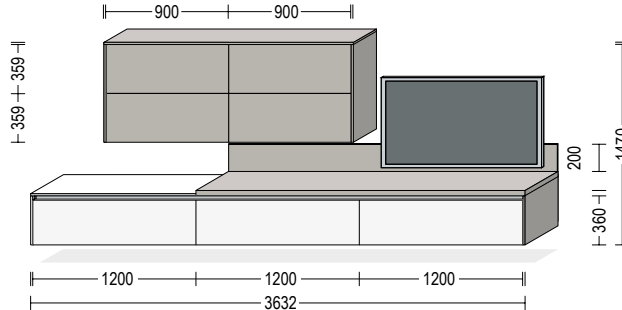

- |                 |  |                |  |
|-----------------|--|----------------|--|
| 3 × NBUA 120-36 | Badezimmer-Auszugschrank, 1 Auszug, B × H × T: 1200 × 360 × 461 mm<br>Bathroom pull-out unit, 1 pull-out, w × h × d: 1200 × 360 × 461 mm | 2 × NBUW 16-36 | LINE N-Abschlusswange, 16 mm stark, H × T: 360 × 482 mm<br>LINE N upright at end of run, 16 mm thick, h × d: 360 × 482 mm                  |
| 1 × ADB16 59    | Abdeckboden, 16 mm stark, B × T: 1218 × 487 mm<br>Top shelf, 16 mm thick, w × d: 1218 × 487 mm   | 4 × WKB 90-36  | Wandschrank mit Barklappe, 1 Klappe, B × H × T: 900 × 359 × 320 mm<br>Wall unit with bar flap, 1 flap, w × h × d: 900 × 359 × 320 mm       |
| 1 × APD60       | Arbeitsplatte APD, 38 mm stark, B × T: 2418 × 487 mm<br>Worktop APD, 38 mm thick, w × d: 2418 × 487 mm                                   | 1 × ADB16 35   | Abdeckboden, 16 mm stark, B × T: 1836 × 346 mm<br>Top shelf, 16 mm thick, w × d: 1836 × 346 mm   |
| 1 × NV203       | Nischenwandverkleidung, 16 mm stark, B × H: 2418 × 200 mm<br>Niche cladding, 16 mm thick, w × h: 2418 × 200 mm                           | 2 × WW 16-02   | Abschluss-/Zwischenwange, 16 mm stark, H × T: 718 × 344 mm<br>Upright at end of run/intermediate upright, 16 mm thick, h × d: 718 × 344 mm |

### WSET14

Seite 42-43  
page 42-43

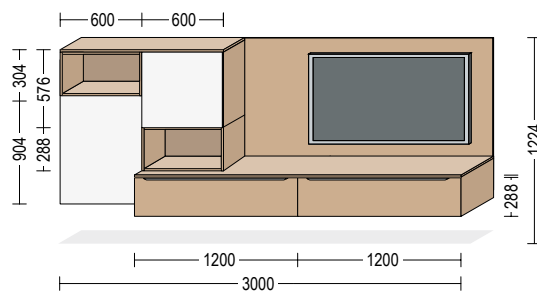

- |                |  |              |  |
|----------------|--|--------------|--|
| 1 × W 60-03    | Wandschrank, 1 Tür, 2 Einlegeböden, B × H × T: 600 × 904 × 320 mm<br>Wall unit, 1 door, 2 shelves, w × h × d: 600 × 904 × 320 mm   | 1 × ADB16 35 | Abdeckboden, 16 mm stark, B × T: 1204 × 346 mm<br>Top shelf, 16 mm thick, w × d: 1204 × 346 mm                 |
| 1 × WR 60-36   | Wandregal, B × H × T: 600 × Sondermaß 304 × 335 mm<br>Open shelf wall unit, w × h × d: 600 × special size 304 × 335 mm   | 1 × ADB16 59 | Abdeckboden, 16 mm stark, B × T: 2402 × 487 mm<br>Top shelf, 16 mm thick, w × d: 2402 × 487 mm                 |
| 2 × BUA 120-29 | Badezimmer-Auszugschrank, 1 Auszug, B × H × T: 1200 × 288 × 461 mm<br>Bathroom pull-out unit, 1 pull-out, w × h × d: 1200 × 288 × 461 mm                                   | 1 × NV203    | Nischenwandverkleidung, 16 mm stark, B × H: 1802 × 904 mm<br>Niche cladding, 16 mm thick, w × h: 1802 × 904 mm |
| 1 × WR 60-36   | Wandregal, B × H × T: 600 × Sondermaß 328 × 335 mm<br>Open shelf wall unit, w × h × d: 600 × special size 328 × 335 mm   |              |  |
| 1 × BU 60-58   | Badezimmer-Unterschrank, 1 Tür, 1 Einlegeboden, B × H × T: 600 × 576 × Sondermaß 320 mm<br>Bathroom base unit, 1 door, 1 shelf, w × h × d: 600 × 576 × special size 320 mm |              |  |

## Wohngefühl Living atmosphere

### WSET15

Seite 32-33  
page 32-33

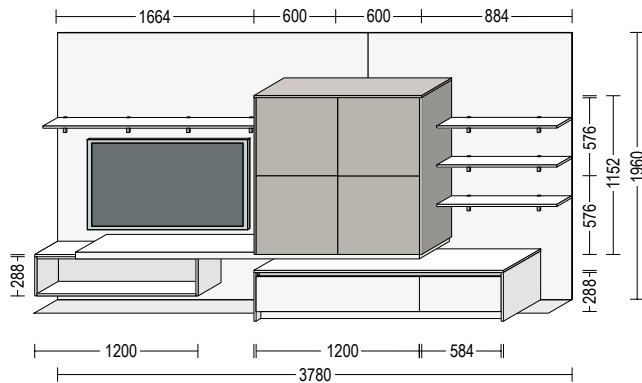

- |               |  |              |  |
|---------------|--|--------------|--|
| 1 × WR 120-36 | <b>Wandregal, B × H × T: 1200 × Sondermaß 288 × 335 mm</b><br>Open shelf wall unit, w × h × d: 1200 × special size 288 × 335 mm                                | 1 × ADB16 59 | <b>Abdeckboden, 16 mm stark, B × T: 1836 × 487 mm</b><br>Top shelf, 16 mm thick, w × d: 1836 × 487 mm  |
| 1 × ADB16 35  | <b>Abdeckboden, 16 mm stark, B × T: 302 × 346 mm</b><br>Top shelf, 16 mm thick, w × d: 302 × 346 mm  | 2 × UWA16    | <b>Abschlusswange inkl. Bodenprofil, 16 mm stark, H × T: 358 × 585 mm</b><br>Upright at end of run incl. floor seal, 16 mm thick, h × d: 358 × 585 mm              |
| 1 × NV203     | <b>Nischenwandverkleidung, 16 mm stark, B × H: 2280 × 1960 mm</b><br>Niche cladding, 16 mm thick, w × h: 2280 × 1960 mm  | 4 × BU 60-58 | <b>Badzimmer-Unterschrank, 1 Tür, 1 Einlegeboden, B × H × T: 600 × 576 × 461 mm</b><br>Bathroom base unit, 1 door, 1 shelf, w × h × d: 600 × 576 × 461 mm          |
| 1 × VB16 258  | <b>Wandbord, 16 mm stark, B × T: 1664 × 255 mm</b><br>Wall shelf, 16 mm thick, w × d: 1664 × 255 mm  | 1 × ADB16 59 | <b>Abdeckboden, 16 mm stark, B × T: 1236 × 487 mm</b><br>Top shelf, 16 mm thick, w × d: 1236 × 487 mm  |
| 1 × ADB50 59  | <b>Abdeckboden, 50 mm stark, B × T: 2580 × 461 mm</b><br>Top shelf, 50 mm thick, w × d: 2580 × 461 mm  | 2 × HWK 16   | <b>Abschlusswange, 16 mm stark, H × T: Sondermaß 1152 × Sondermaß 485 mm</b><br>Upright at end of run, 16 mm thick, h × d: special size 1152 × special size 485 mm |
| 1 × UA 120-29 | <b>Auszugsschrank/Kochstellenschrank, 1 Auszug, B × H × T: 1200 × 288 × 561 mm</b><br>Pull-out unit/hot plate unit, 1 pull-out, w × h × d: 1200 × 288 × 561 mm | 1 × NV203    | <b>Nischenwandverkleidung, 16 mm stark, B × H: 1500 × 1960 mm</b><br>Niche cladding, 16 mm thick, w × h: 1500 × 1960 mm  |
| 2 × MP-PSO    | <b>Mehrp reis-Sockel</b><br>Surcharge for plinth   | 3 × VB16 100 | <b>Wandbord, 16 mm stark, B × T: 884 × 255 mm</b><br>Wall shelf, 16 mm thick, w × d: 884 × 255 mm  |
| 1 × UA 60-29  | <b>Auszugsschrank/Kochstellenschrank, 1 Auszug, B × H × T: 600 × 288 × 561 mm</b><br>Pull-out unit/hot plate unit, 1 pull-out, w × h × d: 600 × 288 × 561 mm   | 1 × PTO5     | <b>Mechanische Öffnungsunterstützung</b><br>Opening support mechanism  |

### WSET16

Seite 34-35  
page 34-35

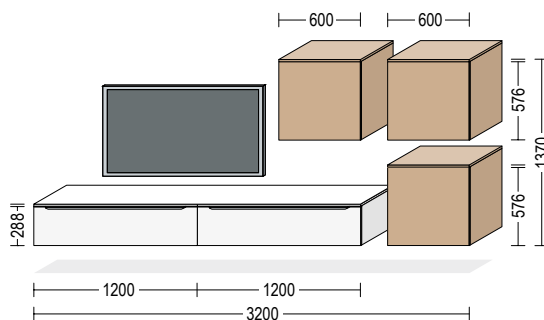

- |                |   |              |   |
|----------------|---|--------------|---|
| 2 × BUA 120-29 | <b>Badzimmer-Auszugsschrank, 1 Auszug, B × H × T: 1200 × 288 × 461 mm</b><br>Bathroom pull-out unit, 1 pull-out, w × h × d: 1200 × 288 × 461 mm           | 3 × ADB16 59 | <b>Abdeckboden, 16 mm stark, B × T: 604 × 487 mm</b><br>Top shelf, 16 mm thick, w × d: 604 × 487 mm |
| 1 × ADB16 59   | <b>Abdeckboden, 16 mm stark, B × T: 2404 × 487 mm</b><br>Top shelf, 16 mm thick, w × d: 2404 × 487 mm   | 1 × PTO5     | <b>Mechanische Öffnungsunterstützung</b><br>Opening support mechanism                               |
| 3 × BU 60-58   | <b>Badzimmer-Unterschrank, 1 Tür, 1 Einlegeboden, B × H × T: 600 × 576 × 461 mm</b><br>Bathroom base unit, 1 door, 1 shelf, w × h × d: 600 × 576 × 461 mm |              |   |



# SPEZIFIKATIONEN SPECIFICATIONS

Die Planungsvorschläge enthalten keine Leuchten oder Griffleisten-Mehrpriese. Diese müssen zusätzlich zur Set-Artikelnummer bestellt werden.

Sondermaße gegen Mehrpreis. TV-Geräte und Dekorationsartikel sind nicht enthalten.

The planning suggestions do not include lights or surcharges for handles. These must be ordered in addition to the set item number.

Special dimensions for a surcharge. TVs and decorative items are not included.

## Genussmoment Moments of enjoyment

### DINSET01

Seite 62-63  
page 62-63

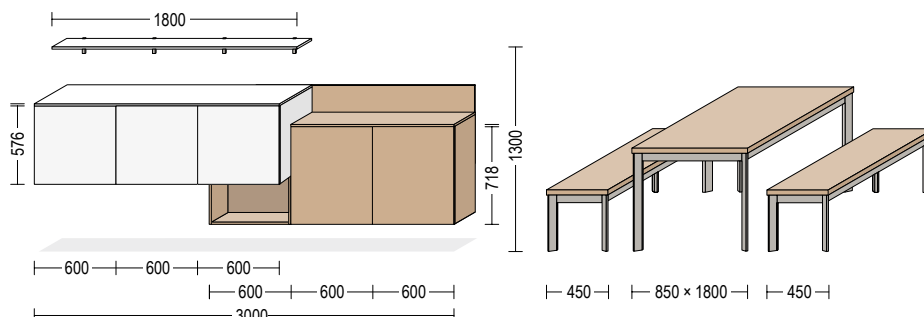

- 3 × BU 60-58** **Badezimmer-Unterschrank, 1 Tür, 1 Einlegeboden, B × H × T: 600 × 576 × 461 mm**  
Bathroom base unit, 1 door, 1 shelf, w × h × d: 600 × 576 × 461 mm
- 1 × WR 60-36** **Wandregal, B × H × T: 600 × 359 × 335 mm**  
Open shelf wall unit, w × h × d: 600 × 359 × 335 mm
- 1 × ADB16 59** **Abdeckboden, 16 mm stark, B × T: 1804 × 487 mm**  
Top shelf, 16 mm thick, w × d: 1804 × 487 mm
- 2 × W 60-02** **Wandschrank, 1 Tür, 2 Einlegeböden, B × H × T: 600 × 718 × 320 mm**  
Wall unit, 1 door, 2 shelves, w × h × d: 600 × 718 × 320 mm
- 1 × ADB16 36** **Abdeckboden, 16 mm stark, B × T: 1202 × 346 mm**  
Top shelf, 16 mm thick, w × d: 1202 × 346 mm
- 1 × NV203** **Nischenwandverkleidung, 16 mm stark, B × H: 1202 × 201 mm**  
Niche cladding, 16 mm thick, w × h: 1202 × 201 mm
- 1 × VB16 258** **Wandbord mit Bodenhaltern, 16 mm stark, B × T: 1804 × 255 mm**  
Wall shelf unit with shelf holders, 16 mm thick, w × d: 1804 × 255 mm

- 1 × PTO5** **Mechanische Öffnungsunterstützung**  
Opening support mechanism
- 2 × ABGF 180** **Bankgestell, B × H × T: 1792 × 415 × 442 mm**  
Bench base, w × h × d: 1792 × 415 × 442 mm
- 2 × APD60** **Arbeitsplatte APD mit Dekorkante, 38 mm stark, B × T: 1800 × 450 mm**  
Worktop APD with décor edge, 38 mm thick, w × d: 1800 × 450 mm
- 1 × ATGF180** **Tischgestell, B × H × T: 1792 × 720 × 842 mm**  
Table frame, w × h × d: 1792 × 720 × 842 mm
- 1 × APD90** **Arbeitsplatte APD mit Dekorkante, 38 mm stark, B × T: 1800 × 850 mm**  
Worktop APD with décor edge, 38 mm thick, w × d: 1800 × 850 mm
- 3 × APD-K** **Mehrpreis für zusätzliche Kantenbelegung**  
Surcharge for additional edging

### DINSET02

Seite 54-57  
page 54-57

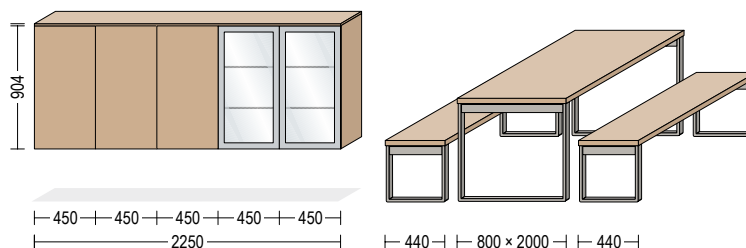

- 3 × W 45-03** **Wandschrank, 1 Tür, 2 Einlegeböden, B × H × T: 450 × 904 × 320 mm**  
Wall unit, 1 door, 2 shelves, w × h × d: 450 × 904 × 320 mm
- 2 × WSQ 45-03** **Glas-Wandschrank Square, 1 Alu-Rahmentür, 2 Glaseinlegeböden, B × H × T: 450 × 904 × 320 mm**  
Wall unit with glass doors Square, 1 aluminium framed door, 2 glass shelves, w × h × d: 450 × 904 × 320 mm
- 1 × ADB16 35** **Abdeckboden, 16 mm stark, B × T: 2254 × 346 mm**  
Top shelf, 16 mm thick, w × d: 2254 × 346 mm
- 1 × PTO5** **Mechanische Öffnungsunterstützung**  
Opening support mechanism
- 2 × ABG** **Bankgestell, H × T: 415 × 430 mm, 1490 - 2490 mm lang**  
Bench base, h × d: 415 × 430 mm, 1490 - 2490 mm long
- 2 × APD60** **Arbeitsplatte APD mit Dekorkante, 38 mm stark, B × T: 2000 × 440 mm**  
Worktop APD with décor edge, 38 mm thick, w × d: 2000 × 440 mm
- 1 × ATG-E** **Tischgestell, H × T: 720 × 790 mm, 1490 - 2490 mm lang**  
Table frame, h × d: 720 × 790 mm, 1490 - 2490 mm long
- 1 × APD80** **Arbeitsplatte APD mit Dekorkante, 38 mm stark, B × T: 2000 × 800 mm**  
Worktop APD with décor edge, 38 mm thick, w × d: 2000 × 800 mm
- 3 × APD-K** **Mehrpreis für zusätzliche Kantenbelegung**  
Surcharge for additional edging

\*Bitte beachten Sie, dass ein Distanzband für die Montage erforderlich ist, um Kollisionen zwischen der Front und den horizontal angebrachten Teilen zu vermeiden.  
Please note that a spacer tape is required when planning top shelves and folding/lifting door and swivel flap units, to prevent the front contacting the top shelf.

## Genussmoment Moments of enjoyment

### DINSET03\*

Seite 60-61  
page 60-61

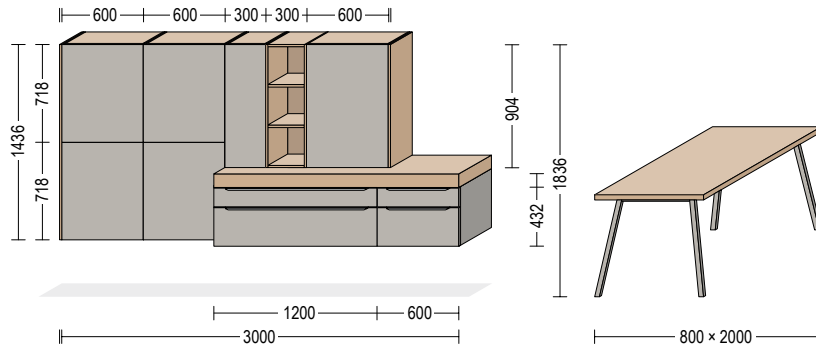

- |                 |  |              |   |
|-----------------|--|--------------|---|
| 4 × W 60-02     | <b>Wandschrank, 1 Tür, 2 Einlegeböden, B × H × T: 600 × 718 × 320 mm</b><br>Wall unit, 1 door, 2 shelves, w × h × d: 600 × 718 × 320 mm                                  | 1 × WR 30-03 | <b>Wandregal, 2 feste Böden, B × H × T: 300 × 904 × 335 mm</b><br>Open shelf wall unit, 2 fixed shelves, w × h × d: 300 × 904 × 335 mm            |
| 1 × HWK 16      | <b>Abschlusswange, 16 mm stark, H × T: 1440 × 344 mm</b><br>Upright at end of run, 16 mm thick, h × d: 1440 × 344 mm   | 1 × W 60-03  | <b>Wandschrank, 1 Tür, 2 Einlegeböden, B × H × T: 600 × 904 × 320 mm</b><br>Wall unit, 1 door, 2 shelves, w × h × d: 600 × 904 × 320 mm           |
| 1 × BUSA 120-43 | <b>Badezimmer-Auszugschrank, 1 Schubkasten, 1 Auszug, B × H × T: 1200 × 432 × 461 mm</b><br>Bathroom pull-out unit, 1 drawer, 1 pull-out, w × h × d: 1200 × 432 × 461 mm | 1 × WW 16-03 | <b>Abschluss-/Zwischenwange, 16 mm stark, H × T: 907 × 344 mm</b><br>Upright at end of run/intermediate upright, 16 mm thick, h × d: 907 × 344 mm |
| 1 × BUSA 60-43  | <b>Badezimmer-Auszugschrank, 1 Schubkasten, 1 Auszug, B × H × T: 600 × 432 × 461 mm</b><br>Bathroom pull-out unit, 1 pull-out, w × h × d: 600 × 432 × 461 mm             | 1 × ATGT-E   | <b>Tischgestell, H × T: 711 × 800 mm, 1400 - 2000 mm lang</b><br>Table frame, h × d: 711 × 800 mm, 1400 - 2000 mm long                            |
| 1 × APP         | <b>Pultplatte, 100 mm stark, B × T: 1800 × 487 mm</b><br>Console panel, 100 mm thick, w × d: 1800 × 487 mm   | 1 × APD80    | <b>Arbeitsplatte APD mit Dekorkante, 38 mm stark, B × T: 2000 × 800 mm</b><br>Worktop APD with décor edge, 38 mm thick, w × d: 2000 × 800 mm      |
| 2 × W 30-03     | <b>Wandschrank, 1 Tür, 2 Einlegeböden, B × H × T: 300 × 904 × 320 mm</b><br>Wall unit, 1 door, 2 shelves, w × h × d: 300 × 904 × 320 mm                                  | 1 × APD-K    | <b>Mehrpreis für zusätzliche Kantenbelegung</b><br>Surcharge for additional edging  |

### DINSET04

Seite 58-59  
page 58-59

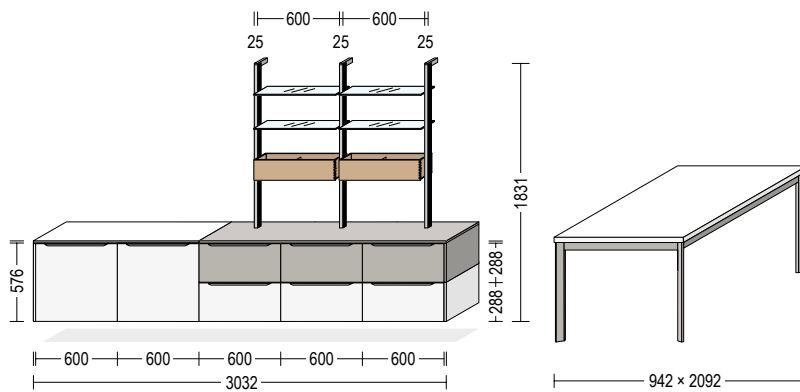

- |               |  |                |  |
|---------------|--|----------------|--|
| 2 × BU 60-58  | <b>Badezimmer-Unterschrank, 1 Tür, 1 Einlegeboden, B × H × T: 600 × 576 × 461 mm</b><br>Bathroom base unit, 1 door, 1 shelf, w × h × d: 600 × 576 × 461 mm | 4 × RSG 60     | <b>Glasboden, 8 mm stark, B × T: 600 × 220 mm</b><br>Glass shelf, 8 mm thick, w × d: 600 × 220 mm  |
| 1 × ADB16 59  | <b>Abdeckboden, 16 mm stark, B × T: 1218 × 487 mm</b><br>Top shelf, 16 mm thick, w × d: 1218 × 487 mm  | 2 × RSHK 60-H  | <b>Holzkasten, B × H × T: 600 × 150 × 170 mm</b><br>Wooden box, w × h × d: 600 × 150 × 170 mm  |
| 1 × BUW 16-58 | <b>Abschlusswange, 16 mm stark, H × T: 576 × 485 mm</b><br>Upright at end of run, 16 mm thick, h × d: 576 × 485 mm   | 2 × RSKRS 60-H | <b>Kunststoff Kräuterschale, 2 Stück, B × H: 600 × 125 mm</b><br>Plastic herb pot, 2 pieces, w × h: 600 × 125 mm                             |
| 6 × BUA 60-29 | <b>Badezimmer-Auszugschrank, 1 Auszug, B × H × T: 600 × 288 × 461 mm</b><br>Bathroom pull-out unit, 1 pull-out, w × h × d: 600 × 288 × 461 mm              | 1 × ATGO 210-S | <b>Tischgestell Otello, H × T: 732 × 942 mm, 2092 mm lang</b><br>Table frame Otello, h × d: 732 × 942 mm, 2092 mm long                       |
| 1 × ADB16 59  | <b>Abdeckboden, 16 mm stark, B × T: 1818 × 487 mm</b><br>Top shelf, 16 mm thick, w × d: 1818 × 487 mm  | 1 × APD100     | <b>Arbeitsplatte APD mit Dekorkante, 38 mm stark, B × T: 2100 × 950 mm</b><br>Worktop APD with décor edge, 38 mm thick, w × d: 2100 × 950 mm |
| 2 × BUW 16-29 | <b>Abschlusswange, 16 mm stark, H × T: 288 × 485 mm</b><br>Upright at end of run, 16 mm thick, h × d: 288 × 485 mm   | 1 × APD-K      | <b>Mehrpreis für zusätzliche Kantenbelegung</b><br>Surcharge for additional edging   |
| 3 × ARS 15-02 | <b>Aluminiumstollen in Aufsatzschrankhöhe O2, T: 150 mm</b><br>Aluminium support poles in dresser unit height O2, d: 150 mm                                |                |  |

# SPEZIFIKATIONEN SPECIFICATIONS

Die Planungsvorschläge enthalten keine Leuchten oder Griffleisten-Mehrpriese. Diese müssen zusätzlich zur Set-Artikelnummer bestellt werden.

Sondermaße gegen Mehrpreis. TV-Geräte und Dekorationsartikel sind nicht enthalten.

The planning suggestions do not include lights or surcharges for handles. These must be ordered in addition to the set item number.

Special dimensions for a surcharge. TVs and decorative items are not included.

## Ordnungsliebe A love of order

### GSET01

Seite 64-67  
page 64-67

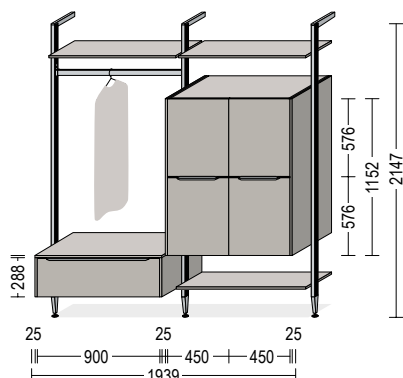

- |               |   |                 |  |
|---------------|---|-----------------|--|
| 3 × HRS 30-02 | <b>Aluminiumstollen in Hochschrankhöhe 02, T: 295 mm</b><br>Aluminium support poles in tall unit height 02, d: 295 mm                         | 3 × RSB16 90-38 | <b>Regalboden, 16 mm stark, B × T: Sondermaß 932 × 380 mm</b><br>Shelf, 16 mm thick, w × d: special size 932 × 380 mm                                      |
| 1 × BUA 90-29 | <b>Badezimmer-Auszugschrank, 1 Auszug, B × H × T: 900 × 288 × 461 mm</b><br>Bathroom pull-out unit, 1 pull-out, w × h × d: 900 × 288 × 461 mm | 2 × HWK 16      | <b>Abschlusswange, 16 mm stark, H × T: 1152 × 485 mm</b><br>Upright at end of run, 16 mm thick, h × d: 1152 × 485 mm                                       |
| 1 × ADB16 59  | <b>Abdeckboden, 16 mm stark, B × T: 932 × 487 mm</b><br>Top shelf, 16 mm thick, w × d: 932 × 487 mm   | 4 × BU 45-58    | <b>Badezimmer-Unterschrank, 1 Tür, 1 Einlegeboden, B × H × T: 450 × 576 × 461 mm</b><br>Bathroom base unit, 1 door, 1 shelf, w × h × d: 450 × 576 × 461 mm |
| 2 × BUW 16-29 | <b>Abschlusswange, 16 mm stark, H × T: 288 × 485 mm</b><br>Upright at end of run, 16 mm thick, h × d: 288 × 485 mm                            | 3 × RSSK        | <b>Schrank-Konnektor</b><br>Unit connector   |
| 1 × RSKST 93  | <b>Kleiderstange, B: 932 mm</b><br>Clothes rail, w: 932 mm  |                 |  |

### GSET02

Seite 68-69  
page 68-69

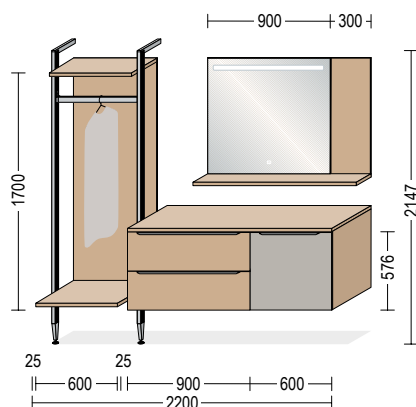

- |                 |  |               |   |
|-----------------|--|---------------|---|
| 2 × HRS 30-02   | <b>Aluminiumstollen in Hochschrankhöhe 02, T: 295 mm</b><br>Aluminium support poles in tall unit height 02, d: 295 mm                                      | 1 × ADB25 59  | <b>Abdeckboden, 25 mm stark, B × T: 1504 × 487 mm</b><br>Top shelf, 25 mm thick, w × d: 1504 × 487 mm                         |
| 2 × RSB25 60-38 | <b>Regalboden, 25 mm stark, B × T: 600 × 380 mm</b><br>Shelf, 25 mm thick, w × d: 600 × 380 mm   | 1 × WB 25-120 | <b>Wand-Steckbord, 25 mm stark, B × T: 1200 × 255 mm</b><br>Plug-in wall shelf, 25 mm thick, w × d: 1200 × 255 mm             |
| 1 × RSKST 60    | <b>Kleiderstange, B: 600 mm</b><br>Clothes rail, w: 600 mm   | 1 × SPLH 90   | <b>Spiegel mit horizontalem LED-Lichtfenster, H × T: 850 × 24 mm</b><br>Mirror with horizontal LED lights, h × d: 850 × 24 mm |
| 1 × NV203       | <b>Nischenwandverkleidung, 16 mm stark, B × H: 600 × 1700 mm</b><br>Niche cladding, 16 mm thick, w × h: 600 × 1700 mm                                      | 1 × NV203     | <b>Nischenwandverkleidung, 16 mm stark, B × H: 1200 × 850 mm</b><br>Niche cladding, 16 mm thick, w × h: 1200 × 850 mm         |
| 1 × BU2A 90-58  | <b>Badezimmer-Auszugschrank, 2 Auszüge, B × H × T: 900 × 576 × 461 mm</b><br>Bathroom pull-out unit, 2 pull-outs, w × h × d: 900 × 576 × 461 mm            |               |   |
| 1 × BU 60-58    | <b>Badezimmer-Unterschrank, 1 Tür, 1 Einlegeboden, B × H × T: 600 × 576 × 461 mm</b><br>Bathroom base unit, 1 door, 1 shelf, w × h × d: 600 × 576 × 461 mm |               |   |



**GSET03**

Seite 70-71  
page 70-71

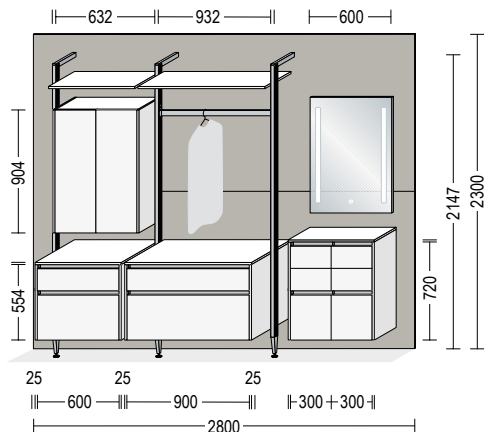

- 3 × HRS 30-02 Aluminiumstollen in Hochschrankhöhe 02, T: 295 mm**  
Aluminium support poles in tall unit height 02, d: 295 mm
- 1 × NBUSA 60-55 Badezimmer-Auszugschrank, 1 Schubkasten, 1 Auszug, B × H × T: 600 × 554 × 461 mm**  
Bathroom pull-out unit, 1 drawer, 1 pull-out, w × h × d: 600 × 554 × 461 mm
- 1 × ADB16 59 Abdeckboden, 16 mm stark, B × T: 632 × 484 mm**  
Top shelf, 16 mm thick, w × d: 632 × 484 mm
- 1 × NBUSA 90-55 Badezimmer-Auszugschrank, 1 Schubkasten, 1 Auszug, B × H × T: 900 × 554 × 461 mm**  
Bathroom pull-out unit, 1 drawer, 1 pull-out, w × h × d: 900 × 554 × 461 mm
- 1 × ADB16 59 Abdeckboden, 16 mm stark, B × T: 932 × 484 mm**  
Top shelf, 16 mm thick, w × d: 932 × 484 mm
- 4 × NBUW 16-55 Abschlusswangen, 16 mm stark, H × T: 554 × 482 mm**  
Upright at end of runs, 16 mm thick, h × d: 554 × 482 mm
- 1 × NW2T 60-03 Wandschrank, 2 Türen, 2 Einlegeböden, B × H × T: 600 × 904 × 320 mm**  
Wall unit, 2 doors, 2 shelves, w × h × d: 600 × 904 × 320 mm
- 2 × WW 16-03 Abschluss-/Zwischenwange, 16 mm stark, H × T: 904 × 344 mm**  
Upright at end of run/intermediate upright, 16 mm thick, h × d: 904 × 344 mm
- 1 × RSB16 60-38 Regalboden, 16 mm stark, B × T: Sondermaß 632 × Sondermaß 359 mm**  
Shelf, 16 mm thick, B × T: special size 632 × special size 359 mm

- 1 × RSKST 93 Kleiderstange, B: 932 mm**  
Clothes rail, w: 932 mm
- 1 × RSB16 90-38 Regalboden, 16 mm stark, B × T: Sondermaß 932 × Sondermaß 359 mm**  
Shelf, 16 mm thick, w × d: special size 932 × special size 359 mm
- 2 × NBS2SA 30-72 Badezimmer-Sideboard, 2 Schubkästen, 1 Auszug, B × H × T: 300 × 720 × 320 mm**  
Bathroom sideboard, 2 drawers, 1 pull-out, w × h × d: 300 × 720 × 320 mm
- 1 × ADB16 35 Abdeckboden, 16 mm stark, B × T: 636 × 343 mm**  
Top shelf, 16 mm thick, w × d: 636 × 343 mm
- 2 × NBSW 16-72 LINE N-Abschlusswange, 16 mm stark, H × T: 720 × 341 mm**  
LINE N upright at end of run, 16 mm thick, h × d: 720 × 341 mm
- 1 × SPLV 60 Spiegel mit vertikalen LED-Lichtfenstern, H × T: 850 × 24 mm**  
Mirror with vertical LED light windows, h × d: 850 × 24 mm
- 2 × NVM120 Nischenverkleidung mit Motiv im Digitalprint, 16 mm stark, B × H: 2800 × 1150 mm**  
Niche cladding with digitally printed motif, 16 mm thick, w × h: 2800 × 1150 mm
- 3 × RSSK Schrank-Konnektor**  
Unit connector

# SPEZIFIKATIONEN SPECIFICATIONS

Die Planungsvorschläge enthalten keine Leuchten oder Griffleisten-Mehrpriese. Diese müssen zusätzlich zur Set-Artikelnummer bestellt werden.

Sondermaße gegen Mehrpreis. TV-Geräte und Dekorationsartikel sind nicht enthalten.

The planning suggestions do not include lights or surcharges for handles. These must be ordered in addition to the set item number.

Special dimensions for a surcharge. TVs and decorative items are not included.

## Kleidertraum Clothing dreams

### DRSET01

Seite 72-75  
page 72-75

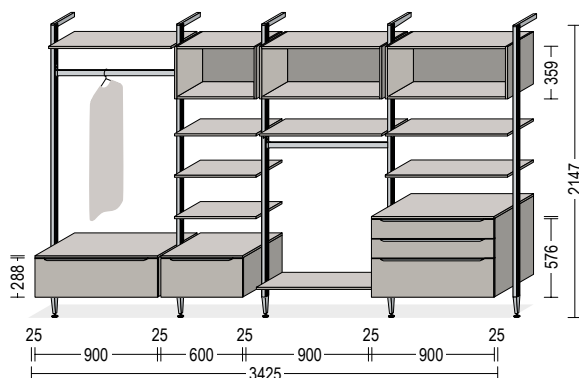

- |                 |   |                 |   |
|-----------------|---|-----------------|---|
| 5 × HRS 30-02   | <b>Aluminiumstollen in Hochschrankhöhe 02, T: 295 mm</b><br>Aluminium support poles in tall unit height 02, d: 295 mm                         | 3 × RSB16 60-38 | <b>Regalboden, 16 mm stark, B × T: 600 × 380 mm</b><br>Shelf, 16 mm thick, w × d: 600 × 380 mm  |
| 1 × BUA 90-29   | <b>Badezimmer-Auszugschrank, 1 Auszug, B × H × T: 900 × 288 × 461 mm</b><br>Bathroom pull-out unit, 1 pull-out, w × h × d: 900 × 288 × 461 mm | 1 × WR 60-36    | <b>Wandregal, B × H × T: 600 × 359 × 335 mm</b><br>Open shelf wall unit, w × h × d: 600 × 359 × 335 mm  |
| 2 × ADB16 59    | <b>Abdeckboden, 16 mm stark, B × T: 900 × 487 mm</b><br>Top shelf, 16 mm thick, w × d: 900 × 487 mm   | 2 × WR 90-36    | <b>Wandregal, B × H × T: 900 × 359 × 335 mm</b><br>Open shelf wall unit, w × h × d: 900 × 359 × 335 mm  |
| 2 × RSKST 90    | <b>Kleiderstange, B: 900 mm</b><br>Clothes rail, w: 900 mm  | 1 × BU2SA 90-58 | <b>Badezimmer-Auszugschrank, 2 Schubkästen, 1 Auszug, B × H × T: 900 × 576 × 461 mm</b><br>Bathroom pull-out unit, 2 drawers, 1 pull-out, w × h × d: 900 × 576 × 461 mm |
| 5 × RSB16 90-38 | <b>Regalboden, 16 mm stark, B × T: 900 × 380 mm</b><br>Shelf, 16 mm thick, w × d: 900 × 380 mm  | 6 × RSSK        | <b>Schrank-Konnektor</b><br>Unit connector  |
| 1 × BUA 60-29   | <b>Badezimmer-Auszugschrank, 1 Auszug, B × H × T: 600 × 288 × 461 mm</b><br>Bathroom pull-out unit, 1 pull-out, w × h × d: 600 × 288 × 461 mm |                 |   |
| 1 × ADB16 59    | <b>Abdeckboden, 16 mm stark, B × T: 600 × 487 mm</b><br>Top shelf, 16 mm thick, w × d: 600 × 487 mm   |                 |   |

# Kleidertraum Clothing dreams

## DRSET02

Seite 76-77  
page 76-77

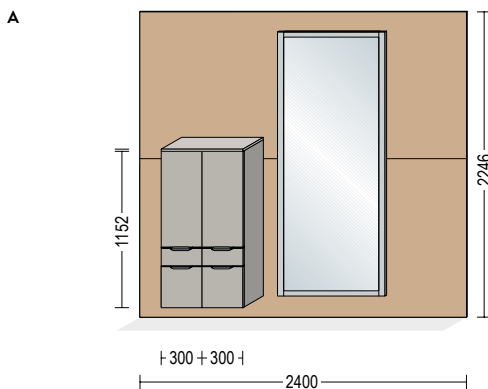
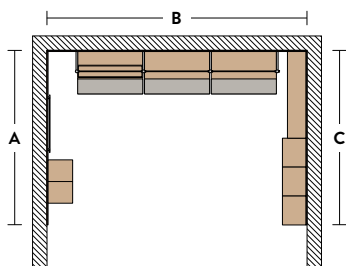

- 1 × NV203 **Nischenwandverkleidung, 16 mm stark, B × H: 2400 × 1192 mm**  
Niche cladding, 16 mm thick, w × h: 2400 × 1192 mm
- 1 × NV203 **Nischenwandverkleidung, 16 mm stark, B × H: 2400 × 1054 mm**  
Niche cladding, 16 mm thick, w × h: 2400 × 1054 mm
- 2 × BMSA 30-115 **Badezimmer-Midischrank, 1 Tür, 1 Schubkasten, 1 Auszug, 2 Einlegeböden, B × H × T: 300 × 1152 × 320 mm**  
Bathroom Midi unit, 1 door, 1 drawer, 1 pull-out, 2 shelves, w × h × d: 300 × 1152 × 320 mm
- 1 × ADB16 35 **Abdeckboden, 16 mm stark, B × T: 604 × 346 mm**  
Top shelf, 16 mm thick, w × d: 604 × 346 mm

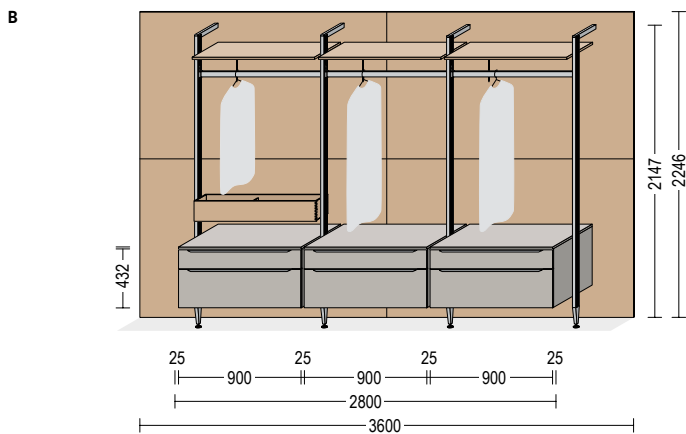

- 2 × NV203 **Nischenwandverkleidung, 16 mm stark, B × H: 1800 × 1054 mm**  
Niche cladding, 16 mm thick, w × h: 1800 × 1054 mm
- 2 × NV203 **Nischenwandverkleidung, 16 mm stark, B × H: 1800 × 1192 mm**  
Niche cladding, 16 mm thick, w × h: 1800 × 1192 mm
- 4 × HRS 30-02 **Aluminiumstollen in Hochschrankhöhe 02, T: 295 mm**  
Aluminium support poles in tall unit height 02, d: 295 mm
- 3 × USARS 90-43 **Auszugschrank, 1 Schubkasten, 1 Auszug, B × H: 900 × 432 mm**  
Pull-out unit, 1 drawer, 1 pull-out, w × h: 900 × 432 mm
- 3 × ADB16 59 **Abdeckboden, 16 mm stark, B × T: 900 × 587 mm**  
Top shelf, 16 mm thick, w × d: 900 × 587 mm
- 3 × RSKST 90 **Kleiderstange, B: 900 mm**  
Clothes rail, w: 900 mm
- 1 × RSHK 90-H **Holzkasten, B × H × T: 900 × 150 × 170 mm**  
Wooden box, w × h × d: 900 × 150 × 170 mm
- 3 × RSB16 90-38 **Regalboden, 16 mm stark, B × T: 900 × 380 mm**  
Shelf, 16 mm thick, w × d: 900 × 380 mm

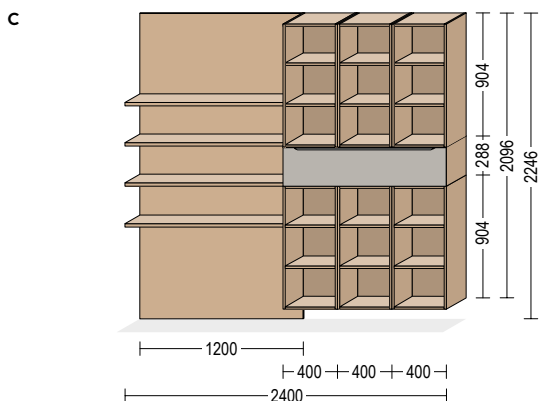

- 1 × NV203 **Nischenwandverkleidung, 16 mm stark, B × H: 1200 × 1054 mm**  
Niche cladding, 16 mm thick, w × h: 1200 × 1054 mm
- 1 × NV203 **Nischenwandverkleidung, 16 mm stark, B × H: 1200 × 1192 mm**  
Niche cladding, 16 mm thick, w × h: 1200 × 1192 mm
- 4 × WB25 120 **Wand-Steckbord, 25 mm stark, B × T: 1200 × 255 mm**  
Plug-in wall shelf, 25 mm thick, w × d: 1200 × 255 mm
- 6 × WR 40-03 **Wandregal 2 feste Böden, B × H × T: 400 × 904 × 335 mm**  
Open shelf wall unit with 2 fixed shelves, w × h × d: 400 × 904 × 335 mm
- 1 × BUA 120-29 **Badezimmer-Auszugschrank, 1 Auszug, B × H × T: 1200 × 288 × Sondermaß 320 mm**  
Bathroom pull-out unit, 1 pull-out, w × h × d: 1200 × 288 × special size 320 mm



# ALLES AUS EINER HAND

## EVERYTHING FROM A SINGLE SOURCE

Vom Wohnzimmer über den Speiseraum bis hin zu Küche und Bad: Das flexible System und die große Auswahl an Fronten und Oberflächen machen es möglich, das Zuhause in einem Stil oder jeden Raum ganz unterschiedlich zu kreieren.

From the living room and dining room to the kitchen and bathroom: the flexible system and large selection of fronts and surfaces make it possible to decorate your home in a single style or design each room differently.



# FRONTEN FRONTS

Fronten, die mit dem LINE N-Logo versehen sind, sind auch als grifflose Planungen lieferbar.  
Fronts marked with the LINE N logo are also available as handleless designs.



**SPEED 244** PG 1  
**Alpinweiß**

SPEED 244 PG 1  
Alpine white



**SPEED 239** PG 1  
**Weiß softmatt**

SPEED 239 PG 1  
White softmatt

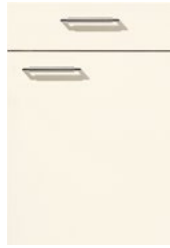

**SPEED 206** PG 1  
**Magnolia softmatt**

SPEED 206 PG 1  
Ivory softmatt



**SPEED 259** PG 1  
**Seidengrau**

SPEED 259 PG 1  
Satin grey



**SPEED 288** PG 1  
**Schwarzbeton  
Nachbildung**

SPEED 288 PG 1  
Black Concrete  
reproduction

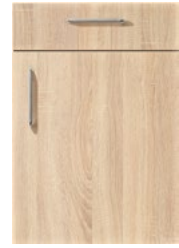

**SPEED 262** PG 1  
**Eiche Virginia  
Nachbildung**

SPEED 262 PG 1  
Virginia oak  
reproduction



**LASER 427** PG 2  
**Alpinweiß**

LASER 427 PG 2  
Alpine white



**LASER 416** PG 2  
**Weiß**

LASER 416 PG 2  
White

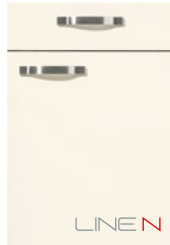

**LASER 418** PG 2  
**Magnolia matt**

LASER 418 PG 2  
Ivory matt



**LASER 417** PG 2  
**Seidengrau**

LASER 417 PG 2  
Satin grey



**LASER 415** PG 2  
**Sand**

LASER 415 PG 2  
Sand

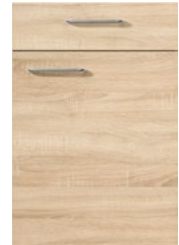

**RIO 666** PG 2  
**Eiche Virginia  
Nachbildung**

RIO 666 PG 2  
Virginia oak  
reproduction

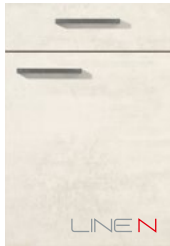

**RIVA 891** PG 2  
**Weißbeton  
Nachbildung**

RIVA 891 PG 2  
White Concrete  
reproduction

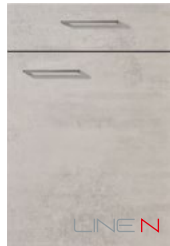

**RIVA 892** PG 2  
**Beton grau  
Nachbildung**

RIVA 892 PG 2  
Concrete grey  
reproduction



**RIVA 889** PG 2  
**Beton schiefergrau  
Nachbildung**

RIVA 889 PG 2  
Concrete Slate Grey  
reproduction



**RIVA 893** PG 2  
**Eiche San Remo  
Nachbildung**

RIVA 893 PG 2  
Sanremo oak  
reproduction



**RIVA 887** PG 2  
**Eiche Somerset  
Nachbildung**

RIVA 887 PG 2  
Somerset oak  
reproduction

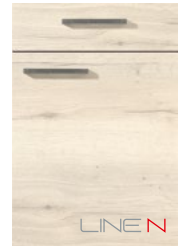

**STRUCTURA 401** PG 3  
**Eiche Halifax  
Nachbildung**

STRUCTURA 401 PG 3  
Sherwood oak  
reproduction



**STRUCTURA 402** PG 3  
**Eiche Havana  
Nachbildung**

STRUCTURA 402 PG 3  
Havana oak  
reproduction



**STRUCTURA 405** PG 3  
**Eiche Sierra  
Nachbildung**

STRUCTURA 405 PG 3  
Sierra oak  
reproduction



**STRUCTURA 403** PG 3  
**Eiche Nero  
Nachbildung**

STRUCTURA 403 PG 3  
Nero oak  
reproduction



**TOUCH 332** PG 3  
**Lacklaminat,  
Alpinweiß supermatt**

TOUCH 332 PG 3  
Lacquered laminate,  
alpine white supermatt



**TOUCH 336** PG 3  
**Lacklaminat,  
Magnolia supermatt**

TOUCH 336 PG 3  
Lacquered laminate,  
ivory supermatt



**TOUCH 338** PG 3  
**Lacklaminat,  
Seidengrau supermatt**

TOUCH 338 PG 3  
Lacquered laminate,  
satin grey supermatt

# FRONTEN FRONTS

Fronten, die mit dem LINE N-Logo versehen sind, sind auch als grifflose Planungen lieferbar.  
 Fronts marked with the LINE N logo are also available as handleless designs.



**TOUCH 341 PG 3**  
**Lacklaminat, Steingrau supermatt**

TOUCH 341 PG 3  
 Lacquered laminate, stone grey supermatt



**TOUCH 337 PG 3**  
**Lacklaminat, Aqua supermatt**

TOUCH 337 PG 3  
 Lacquered laminate, aqua supermatt



**TOUCH 334 PG 3**  
**Lacklaminat, Schiefergrau supermatt**

TOUCH 334 PG 3  
 Lacquered laminate, slate grey supermatt

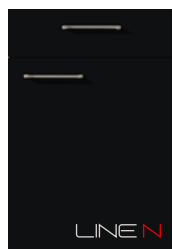

**TOUCH 340 PG 3**  
**Lacklaminat, Schwarz supermatt**

TOUCH 340 PG 3  
 Lacquered laminate, black supermatt



**FLASH 503 PG 3**  
**Lacklaminat, Alpinweiß Hochglanz**

FLASH 503 PG 3  
 Lacquered laminate, alpine white high gloss



**FLASH 450 PG 3**  
**Lacklaminat, Weiß Hochglanz**

FLASH 450 PG 3  
 Lacquered laminate, white high gloss



**FLASH 452 PG 3**  
**Lacklaminat, Magnolia Hochglanz**

FLASH 452 PG 3  
 Lacquered laminate, ivory high gloss



**FLASH 455 PG 3**  
**Lacklaminat, Seidengrau Hochglanz**

FLASH 455 PG 3  
 Lacquered laminate, satin grey high gloss



**FLASH 453 PG 3**  
**Lacklaminat, Schiefergrau Hochglanz**

FLASH 453 PG 3  
 Lacquered laminate, slate grey high gloss



**EASYTOUCH 961 PG 4**  
**Lacklaminat, Grafit schwarz ultramatt**

EASYTOUCH 961 PG 4  
 Lacquered laminate, graphite black ultra matt

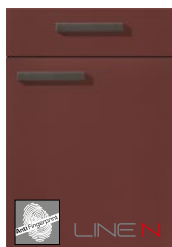

**EASYTOUCH 963 PG 4**  
**Lacklaminat, Rostrot ultramatt**

EASYTOUCH 963 PG 4  
 Lacquered laminate, rust red ultra matt



**STONEART 304 PG 4**  
**Schiefer steingrau Nachbildung**

STONEART 304 PG 4  
 Stone grey slate reproduction



**STONEART 303 PG 4**  
**Grauschiefer Nachbildung**

STONEART 303 PG 4  
 Grey slate reproduction



**INOX 216 PG 4**  
**Lacklaminat, Stahl gebürstet Nachbildung**

INOX 216 PG 4  
 Lacquered laminate, brushed steel reproduction



**FASHION 168 PG 4**  
**Lack, Alpinweiß matt**

FASHION 168 PG 4  
 Lacquer, honed alpine white



**FASHION 173 PG 4**  
**Lack, Weiß matt**

FASHION 173 PG 4  
 Lacquer, honed white



**FASHION 175 PG 4**  
**Lack, Magnolia matt**

FASHION 175 PG 4  
 Lacquer, honed ivory



**FASHION 171 PG 4**  
**Lack, Seidengrau matt**

FASHION 171 PG 4  
 Lacquer, honed satin grey



**FASHION 165 PG 4**  
**Lack, Steingrau matt**

FASHION 165 PG 4  
 Lacquer, honed stone grey



**FOCUS 470 PG 4**  
**Lack, Alpinweiß Ultra-Hochglanz**

FOCUS 470 PG 4  
 Lacquer, alpine white ultra high gloss



**FOCUS 460 PG 4**  
**Lack, Weiß Ultra-Hochglanz**

FOCUS 460 PG 4  
 Lacquer, white ultra high gloss



**FOCUS 462 PG 4**  
**Lack, Magnolia Ultra-Hochglanz**

FOCUS 462 PG 4  
 Lacquer, ivory ultra high gloss



**FOCUS 467 PG 4**  
**Lack, Sand Ultra-Hochglanz**

FOCUS 467 PG 4  
 Lacquer, sand ultra high gloss



**INLINE 551 PG 5**  
**Lack, Alpinweiß matt**

INLINE 551 PG 5  
 Lacquer, honed alpine white





**GENT 741** PG 5  
**Lacklaminat, Steingrau**

GENT 741 PG 5  
Lacquered laminate, stone grey



**CREDO 764** PG 6  
**Lacklaminat, Alpinweiß**

CREDO 764 PG 6  
Lacquered laminate, alpine white



**CREDO 765** PG 6  
**Lacklaminat, Schiefergrau**

CREDO 765 PG 6  
Lacquered laminate, slate grey



**KANSAS 597** PG 7  
**Eiche Sierra Nachbildung**

KANSAS 597 PG 7  
Sierra oak reproduction



**CASCADA 774** PG 7  
**Lacklaminat, Weiß**

CASCADA 774 PG 7  
Lacquered laminate, white



**CASCADA 772** PG 7  
**Lacklaminat, Steingrau**

CASCADA 772 PG 7  
Lacquered laminate, stone grey



**CASCADA 776** PG 7  
**Lacklaminat, Schilf**

CASCADA 776 PG 7  
Lacquered laminate, reed green



**SYLT 847** PG 7  
**Lack, Alpinweiß matt**

SYLT 847 PG 7  
Lacquer, honed alpine white



**SYLT 849** PG 7  
**Lack, Magnolia matt**

SYLT 849 PG 7  
Lacquer, honed ivory



**SYLT 851** PG 7  
**Lack, Schwarz matt**

SYLT 851 PG 7  
Lacquer, honed black



**CASTELLO 390** PG 8  
**Magnolia gewischt**

CASTELLO 390 PG 8  
Washed ivory

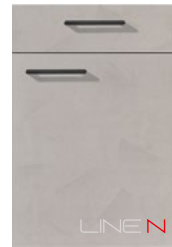

**CEMENTO 803** PG 8  
**Lack, Zementgrau**

CEMENTO 803 PG 8  
Lacquer, cement grey



**LUX 817** PG 9  
**Lack, Alpinweiß Hochglanz**

LUX 817 PG 9  
Lacquer, alpine white high gloss



**LUX 814** PG 9  
**Lack, Weiß Hochglanz**

LUX 814 PG 9  
Lacquer, white high gloss



**LUX 816** PG 9  
**Lack, Magnolia Hochglanz**

LUX 816 PG 9  
Lacquer, ivory high gloss



**LUX 819** PG 9  
**Lack, Seidengrau Hochglanz**

LUX 819 PG 9  
Lacquer, satin grey high gloss

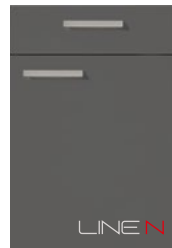

**LUX 823** PG 9  
**Lack, Schiefergrau Hochglanz**

LUX 823 PG 9  
Lacquer, slate grey high gloss

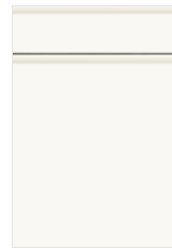

**PURA 834** PG 9  
**Lack, Weiß Hochglanz**

PURA 834 PG 9  
Lacquer, white high gloss



**CHALET 885** PG 9  
**Lack, Weiß matt**

CHALET 885 PG 9  
Lacquer, honed white

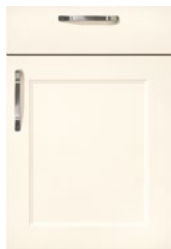

**CHALET 883** PG 9  
**Lack, Magnolia matt**

CHALET 883 PG 9  
Lacquer, honed ivory

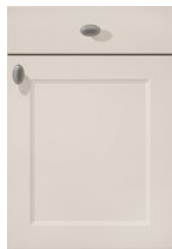

**CHALET 881** PG 9  
**Lack, Sand matt**

CHALET 881 PG 9  
Lacquer, honed sand



**YORK 905** PG 9  
**Echtholz, Magnolia lackiert**

YORK 905 PG 9  
Genuine wood, lacquered ivory



**YORK 901** PG 9  
**Echtholz, Seidengrau lackiert**

YORK 901 PG 9  
Genuine wood, lacquered satin grey

# ARBEITSPLETTEN WORKTOPS

98-99



**066 Schiefer Nachbildung**  
066 Slate décor reproduction



**070\* Seidengrau**  
070\* Satin grey



**078 Eiche San Remo Nachbildung**  
078 Sanremo oak reproduction



**089\* Steingrau**  
089\* Stone grey



**097 Eiche Havanna Nachbildung**  
097 Havana oak reproduction



**117 Copper Vintage Nachbildung**  
117 Vintage Copper décor



**123 Eiche Virginia Nachbildung**  
123 Virginia oak reproduction



**186 Schwarz**  
186 Black



**192 Eiche Provence Nachbildung**  
192 Oak Provence reproduction



**193\* Alpinweiß**  
193\* Alpine white



**194\* Schiefergrau**  
194\* Slate grey



**196 Eiche Ontario Nachbildung**  
196 Ontario oak reproduction



**198 Eiche Sierra Nachbildung**  
198 Sierra oak reproduction



**204 Ponderosa Pine Nachbildung**  
204 Ponderosa pine reproduction



**215 Stromboli hell Nachbildung**  
215 Strombolian light reproduction



**220 Arizona Pine Nachbildung**  
220 Arizona pine reproduction



**225 Stammeiche Nachbildung**  
225 Stem oak reproduction



**226 Dekor Metal Art**  
226 Metal art décor



**265 Rusty Plates Nachbildung**  
265 Rusty plates reproduction



**266 Caledonia**  
266 Caledonia



**272 Balkeneiche Nachbildung**  
272 Timber oak reproduction



**273 Carrara Nachbildung**  
273 Carrara marble reproduction



**274 Marmor Teramo Nachbildung**  
274 Teramo marble reproduction



**316 Maracaibo hell Nachbildung**  
316 Maracaibo light décor



**319 Dekor Oxid**  
319 Oxid décor



**330\* Beton grau Nachbildung**  
330\* Concrete grey reproduction



**344\* Granit schwarz geflammt Nachbildung**  
344\* Black granite décor



**345 Eiche Yukon Nachbildung**  
345 Yukon oak reproduction



**347 Taxus Nachbildung**  
347 Taxus reproduction



**352 Eiche Halifax Nachbildung**  
352 Sherwood oak reproduction



**353\* Weißbeton Nachbildung**  
353\* White Concrete reproduction



**354\* Beton schiefergrau Nachbildung**  
354\* Concrete Slate Grey reproduction



**355\* Ferro Bronze Nachbildung**  
355\* Ferro bronze décor



**356 Endgrain Oak Nachbildung**  
356 Endgrain oak reproduction



**376\* Limestone Nachbildung**  
376\* Limestone reproduction



**377 Eiche geölt Nachbildung**  
377 Oiled oak reproduction



**378 Schwarzbeton Nachbildung**  
378 Black Concrete reproduction



**379 Eiche Somerset Nachbildung**  
379 Somerset oak reproduction



**393 Vintage Oak Nachbildung**  
393 Vintage oak reproduction



**394 Travertin sandbeige Nachbildung**  
394 Champagne travertine reproduction



**395 Verso Nachbildung**  
395 Verso reproduction



**396 Terrazzo grau Nachbildung**  
396 Grey terrazzo reproduction



**Arbeitsplatte APN mit N-Kante**

Worktop APN with N edge



**Arbeitsplatte APD mit Dekorkante**

Worktop APD with décor edge

XTRA



**369\* Schiefer steingrau Nachbildung**  
369\* Stone grey slate reproduction



**373\* Grauschiefer Nachbildung**  
373\* Grey slate reproduction



**367\* Eiche Artisan Nachbildung**  
367\* Artisan oak reproduction



**368 Mixwood Nachbildung**  
368 Mixedwood reproduction



Eine Ansicht der kompletten Dekorlänge finden Sie auf [www.nobilite.de](http://www.nobilite.de)  
A view of the entire length of the décor can be found at [www.nobilite.de](http://www.nobilite.de)

\* Auch als Slim Line-Arbeitsplatte, 16 mm stark, lieferbar.  
\* Also available as Slim Line worktop, 16 mm thick.

# KORPUSDEKORE CARCASE DÉCORS



**193 Alpinweiß**

193 Alpine white



**060 Alpinweiß Glanz**

060 Alpine white gloss



**106 Weiß**

106 White



**022 Weiß Glanz**

022 White gloss

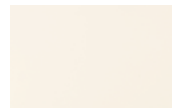

**120 Magnolia matt**

120 Ivory matt

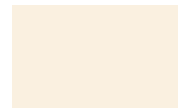

**116 Magnolia Glanz**

116 Ivory gloss

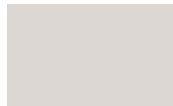

**070 Seidengrau**

070 Satin grey



**089 Steingrau**

089 Stone grey



**122 Sand**

122 Sand



**194 Schiefergrau**

194 Slate grey



**123 Eiche Virginia  
Nachbildung**

123 Virginia oak  
reproduction



**078 Eiche San Remo  
Nachbildung**

078 Sanremo oak  
reproduction



**198 Eiche Sierra  
Nachbildung**

198 Sierra oak  
reproduction



**097 Eiche Havanna  
Nachbildung**

097 Havana oak  
reproduction

# COLOR CONCEPT COLOR CONCEPT



**241 Sonnengelb**

241 Maize Yellow



**248 Farn**

248 Fern



**254 Aqua**

254 Aqua



**257 Salbei**

257 Sage



**265 Rusty Plates  
Nachbildung**

265 Rusty plates  
reproduction



**266 Caledonia**

266 Caledonia

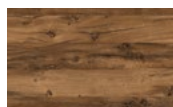

**272 Balkeneiche  
Nachbildung**

272 Timber oak  
reproduction



**273 Carrara  
Nachbildung**

273 Carrara marble  
reproduction



**274 Marmor Teramo  
Nachbildung**

274 Teramo marble  
reproduction



**355 Ferro Bronze  
Nachbildung**

355 Ferro bronze  
décor



# GRIFFAUSWAHL<sup>™</sup> HANDLE SELECTION<sup>™</sup>

## Griffe edelstahlfarbig Handles in stainless steel finish

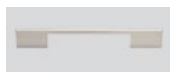

**013\* Metallgriff  
Edelstahlfarbig**

013\* Metal handle  
Stainless steel finish



**019\* Metallgriff  
Edelstahlfarbig**

019\* Metal handle  
Stainless steel finish

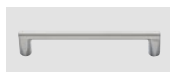

**042 Metallgriff  
Edelstahlfarbig**

042 Metal handle  
Stainless steel finish



**062 Metallgriff  
Edelstahlfarbig**

062 Metal handle  
Stainless steel finish



**067 Metallgriff  
Edelstahlfarbig**

067 Metal handle  
Stainless steel finish



**069 Metallgriff  
Edelstahlfarbig**

069 Metal handle  
Stainless steel finish



**077 Metallgriff  
Edelstahlfarbig**

077 Metal handle  
Stainless steel finish



**098 Metallgriff  
Nickel matt**

098 Metal handle  
Matt nickel



**183 Metallgriff  
Edelstahlfarbig**

183 Metal handle  
Stainless steel finish



**186 Metallgriff  
Edelstahlfarbig**

186 Metal handle  
Stainless steel finish



**218 Metallgriff  
Edelstahlfarbig/  
Chrom Glanz**

218 Metal handle  
Stainless steel finish/  
Brilliant chrome



**221 Metallgriff  
Edelstahlfarbig**

221 Metal handle  
Stainless steel finish



**237 Metallgriff  
Edelstahlfarbig**

237 Metal handle  
Stainless steel finish



**263 Metallgriff  
Edelstahlfarbig**

263 Metal handle  
Stainless steel finish



**279 Metallgriff  
Edelstahlfarbig**

279 Metal handle  
Stainless steel finish



**331 Metallgriff  
Edelstahlfarbig**

331 Metal handle  
Stainless steel finish



**508 Metallgriff  
Edelstahlfarbig**

508 Metal handle  
Stainless steel finish



**544 Metallgriff  
Edelstahlfarbig**

544 Metal handle  
Stainless steel finish



**549 Metallgriff  
Edelstahlfarbig**

549 Metal handle  
Stainless steel finish



**552 Metallgriff  
Edelstahlfarbig**

552 Metal handle  
Stainless steel finish



**602 Metallgriff  
Edelstahlfarbig**

602 Metal handle  
Stainless steel finish



**608 Metallgriff  
Edelstahlfarbig**

608 Metal handle  
Stainless steel finish



**708 Metallgriff  
Edelstahlfarbig**

708 Metal handle  
Stainless steel finish



**801 Metallgriff  
Edelstahlfarbig**

801 Metal handle  
Stainless steel finish

## Griffe Anthrazit/Schwarz Handles in Anthracite/Black



**563 Metallgriff  
Schwarz/Edelstahl-  
farbig**

563 Metal handle  
Black/Stainless steel  
finish



**570 Metallgriff  
Schwarz**

570 Metal handle  
Black



**595 Metallgriff  
Schwarz/Edelstahl-  
farbig**

595 Metal handle  
Black/Stainless steel  
finish



**616 Gusseisengriff  
Schwarz**

616 Cast iron handle  
Black



**707 Metallgriff  
Anthrazit gebürstet**

707 Metal handle  
Brushed anthracite

## Knöpfe Knobs



**610 Gusseisenknopf  
Schwarz**

610 Cast iron knob  
Black



**677 Metallknopf  
Edelstahlfarbig**

677 Metal knob  
Stainless steel finish



**678 Metallknopf  
Edelstahlfarbig**

678 Metal knob  
Stainless steel finish



**679 Metallknopf  
Schwarz**

679 Metal knob  
Black

«Unser gesamtes Angebotsspektrum von Griffen entnehmen Sie bitte unserem Verkaufshandbuch.  
«Please refer to our sales manual for our complete range of handles.

\*Dieser Griff ist mehrpreispflichtig.  
\*This handle requires a surcharge.

## Griffe mit Effektveredelung Handles with effect finishing



**056 Metallgriff**  
Used look

056 Metal handle  
Used look



**088 Metallgriff**  
Anthrazit gebürstet

088 Metal handle  
Brushed anthracite



**099 Metallgriff**  
Industrial Style

099 Metal handle  
Industrial Style



**119 Metallgriff**  
Altsilberfarbig

119 Metal handle  
Antique silver colour



**190\* Bügelgriff**  
Chrom Glanz

190\* Bow handle  
Brilliant chrome



**192 Metallgriff**  
Chrom Glanz

192 Metal handle  
Brilliant chrome



**271 Metallgriff**  
Titanfarbig

271 Metal handle  
Titanium-coloured



**280 Metallgriff**  
Alteisenfarbig

280 Metal handle  
Antique iron colour



**284 Metallgriff**  
Altsilberfarbig

284 Metal handle  
Antique silver colour



**358 Metallgriff**  
Titanfarbig

358 Metal handle  
Titanium-coloured



**509 Metallgriff**  
Grau

509 Metal handle  
grey



**556 Metallgriff**  
Altsilberfarbig

556 Metal handle  
Antique silver colour



**733 Metallgriff**  
Schwarzchrom

733 Metal handle  
Chromed black



**737 Holz-Metallgriff**  
Eiche/Schwarz

737 Wood/Metal  
handle Oak/Black



**739\* Metallgriff**  
Schwarz

739\* Metal handle  
black



**799 Metallgriff**  
Schwarzchrom

799 Metal handle  
Chromed black

## Griffleisten Bar handles



**240\* Griffleiste**  
Schwarz

240\* Bar handle  
Black



**300\* Griffleiste**  
Edelstahlfarbig

300\* Bar handle  
Stainless steel finish

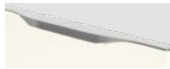

**350\* Griffleiste**  
Edelstahlfarbig

350\* Bar handle  
Stainless steel finish



**430\* Griffleiste**  
Edelstahlfarbig

430\* Bar handle  
Stainless steel finish



**550\* Griffleiste**  
Edelstahlfarbig

550\* Bar handle  
Stainless steel finish



**600\* Griffleiste**  
Schwarz

600\* Bar handle  
Black



**690\* Griffleiste**  
Alpinweiß

690\* Bar handle  
Alpine white



**710\* Griffleiste**  
Steingrau

710\* Bar handle  
Stone grey



**730\* Griffleiste**  
Schiefergrau

730\* Bar handle  
Slate grey



**760\* Griffleiste**  
Edelstahlfarbig

760\* Bar handle  
Stainless steel finish



**870\* Griffleiste**  
Schwarz

870\* Bar handle  
Black

## Relingstangen Railing handles



**370\* Relingstange**  
Edelstahlfarbig

370\* Railing handle  
Stainless steel finish



**620\* Relingstange**  
Schwarz

620\* Railing handle  
Black



**650\* Relingstange**  
Edelstahlfarbig

650\* Railing handle  
Stainless steel finish



**900\* Relingstange**  
Edelstahlfarbig

900\* Railing handle  
Stainless steel finish



**930\* Relingstange**  
Edelstahlfarbig

930\* Railing handle  
Stainless steel finish

**\*Dieser Griff ist mehrpreispflichtig.**

\*This handle requires a surcharge.

Technische Änderungen, Liefermöglichkeiten, Irrtümer und drucktechnisch bedingte Farbabweichungen vorbehalten. Alle Einrichtungsbeispiele sind unverbindlich. All rights to technical alterations, delivery possibilities, errors and printing-related colour deviations are reserved. All furnishing examples are non-binding.



# Qualität made in Germany

## Quality made in Germany

**Ausgesuchte Materialien, exzellente Verarbeitung, Perfektion bis ins Detail: Unsere Möbel werden nach höchsten Qualitätskriterien entwickelt und gefertigt. Dabei produzieren wir ausschließlich am Standort Deutschland.**

**Bevor unsere Produkte in Serie gehen, werden alle eingesetzten Materialien in umfangreichen Testverfahren im Labor auf eine Mindestlebensdauer von 15 Jahren geprüft und durch internationale, unabhängige Institute kontrolliert und zertifiziert. Denn die Zufriedenheit unserer Kunden ist für uns der höchste Maßstab.**

---

Selected materials, excellent workmanship, perfection right down to the finest detail: our furniture is developed and manufactured according to the highest of quality standards. Our products are made exclusively in Germany.

Before our products go into series production, all the materials used are subjected to extensive test procedures in the laboratory for a minimum service life of 15 years and inspected and certified by independent international institutes. After all, our customers' satisfaction is our benchmark.







